

KEY CATALOGUE

Volume IV





Disclaimer

Important

In compliance with current regulations relating to industrial property, we hereby state that the trade-mark or trade names mentioned in our catalogue are the exclusive property of authorized manufacturer of locks and users. Said trade-marks or trade names are nominated only for the purpose of information so that any lock for which our keys are made can be rapidly identified. This catalogue is reserved exclusively for professional key cutters who use Minda-Silca products.

All information and illustration in this catalogue are for guidance only. Minda-Silca reserves the right to alter designs, dimensions or prices without prior notice. The content of this catalogue are fully protected by copyright and may not be copied or reproduced in any form, without written permission from Minda-Silca. Any infringement will be dealt with under Indian law.

ABOUT US		PAGE NO.
Introduction		2
On Line Support		3
KEY IDENTIFICATION		PAGE NO.
Silca Library		4
Electronic Key Catalogue		4
TRANSPONDER INFORMATION		PAGE NO.
Symbology		5
Transponder Replacement		5
Silca Transponder		6
Cloning Solutions		7
Transponders		8
TWO WHEELERS		PAGE NO.
Two Wheelers Keys		9-28
FOUR WHEELERS		PAGE NO.
Four Wheelers Keys		29-40
Commercial Vehicle Keys		41
Key Shells / Remote Covers		42-43
Automotive Remotes		44
Empty Shells		45-48
Look A Like Keys		49-54
Silca Universal Flip Keys		55-57
Universal Flip Keys for Two Wheelers		58-59
Universal Automotive Remotes		60-61
Proximity Keys & Slot Keys		62-70
DOMESTIC KEYS		PAGE NO.
Domestic Keys		71-80
EBTC		PAGE NO.
Workstation / Display Station		82
Chipolo - Bluetooth Tracker		82
Silicone Covers		83
Key Ring		83
Lock Plate Lever		83
Silca Keys & Accessories StorZ		84

Minda Silca Engineering Pvt Ltd., was incepted in the year 2002 under A K Minda Group and was known as "Tuff Engineering Pvt. Ltd." Based at Noida, this company made a humble beginning under AK Minda Group (now known as SPARK MINDA, Ashok Minda Group), to provide Key Solution to all the other group companies.

SPARK MINDA, Ashok Minda Group is a leading manufacturer of Automotive Security Systems, Driver Information Systems, Plastic Injection-Moulded Interior Parts, Die-Casting, Keys and Key Duplicating Machines. The Group caters to the needs of all major Car, Motorcycle, Commercial Vehicles, Tractor and off-road vehicle manufacturers in India and overseas. The Group operates from 35 plants located in India, Germany, Poland, Czech Republic, Indonesia, Vietnam, Germany, Mexico, Uzbekistan with office in Japan. The Group also has several JVs with leading companies from USA, Japan, Italy, and Uzbekistan.

Minda Silca Engineering Pvt. Ltd. was formed in 2006, after a Joint Venture between Spark Minda, Ashok Minda Group & Silca S.p.A, Italy (a member of DormaKaba Group with annual turnover of 2.8 Billion CHF). Silca is the flagship company for the key business within DormaKaba Group. It is a leading European company for manufacturing key blanks, key-cutting machines and equipments dedicated to the production and key blanks processing. Silca also has a product range dedicated to key manufacturing and duplication & security products.

OUR VISION

"To be a dynamic, innovative and profitable precision component manufacturer for automotive as well as non-automotive organization with a special focus on keys & KCM, emerging as the preferred supplier and employer to create value for all stakeholders"

OUR MISSION

- Focusing on product innovation as the essential element to differentiate our offer.
- Looking after our customers needs granting them first class services.
- Upgrading of our production processes both in terms of efficiency and quality.
- Empowering human resources by means of continuous education and training as well as supporting professional growth within the company.
- Pursuing continuous improvement by promoting initiatives and responsibilities at individual and team level.

MINDA SILCA

Minda Silca does not merely represent a trade name, it is an approach to the market, a constant and intense dedication to product quality standards and above all a guarantee of innovation and quality for all the people operating in the world of duplication services.

OUR BUSINESS MODEL

Minda Silca's Business Model is a combination of direct and indirect business covering all the available distribution channels, distributing a complete range of key blanks and key cutting machines dedicated to key cutters, Shoe Bars, Locksmiths and to Industrial users.

KEY CUTTING MACHINES

Minda Silca's Key Cutting Machine System includes the production of machines and dedicated accessories for any type of duplication center up to the production of customized duplicating and originating systems for Lock and Automotive Industries.

Minda Silca's Key Machines product range is wide and very specialized, covering the needs of the key duplication business, including a dedicated range of transponder devices developed to support the most evolute requests.

Long time tradition and solid reputation build up over the years make Silca a very strong brand within this business segment.

ELECTRONIC DUPLICATION

In the eighties, Silca introduced, first in the world, the duplication based on code numbering, marking a technological turn around in the industry.

Now a days, Silca is still representing forefront technology in terms of performance and innovation, for the Lock and Automotive Industry and for Professional Locksmiths all around the world.

SILCA

Silca is the global brand of reference for the production of keys and the production of professional and industrial machines dedicated to key duplication. Silca has been responsible for the most important technological evolutions in key duplication such as the first electronic key cutting machine capable of copying keys

by code. Silca machines are born from a long tradition, from a know-how recognized at a global level and from the expertise and passion of engineers who understand keys in every detail.

QUALITY AND CERTIFICATIONS

Product quality is fundamental to Silca and we invest continuously to guarantee a level of quality that

is both independently certified and designed to last. The recognition received is the result of Silca's commitment to quality and sustainability.

SILCA HOLDS THE FOLLOWING STANDARDS:

- ISO 9001:2015,
- IATF 16949:2016 (Automotive Keys)



On Line Support

THE CATALOGUE

The Catalogue is the largest residential and automotive key database worldwide. The breadth and quality of the information available make it the essential tool to find the key you need. You can search residential keys by original make; or by make, model and year if you're browsing automotive keys. Additional filters can be applied to improve the results. You can also create personalized collections and print out key tags for your display, customizing them with information such as hook position and price.

MY KEYS PRO

It is the essential tool for professional key cutters and auto locksmiths.

Access the most extensive key database in the world, consult key catalogues, see video tutorials, understand the right accessories and use the step-by-step key cutting guides to ensure that you get the absolute maximum from all your Silca key cutting equipment. Futura family and Matrix Pro family key cutting machines also offer 3D interactive animations to guide you on how to correctly position the key in the jaw for perfect cutting results.

MINDA SILCA SALES APP

The essential tool for Dealers, Franchise Businesses (SKAZ) & Locksmiths for online ordering of Keys/Key Duplication/Automotive Devices/Accessories.

Minda Silca App ensures that users get the absolute maximum from all the details given. Users can watch the Latest product Video tutorial, Product information Images, Catalogues, Manage Order History, Wish listings and Give Feedback.

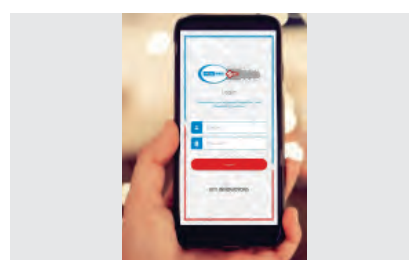

Dear Client,

Our keys are exclusively produced with certified first pick raw materials.

Every single work phase is controlled and carried out with highly advanced machinery, prescribed product quality control certifies: dimensions, aesthetics, and respond to the original product and clients specific request.

Using the SPC (Statistic Process Control) procedure to every single working phase, we guarantee the quality, our customers expect from Minda Silca products. At the end of every work specific test, it assures constant quality, right up to the finished product.

Minda Silca Holds Following Certificate :

IATF :16949:2016 (1st edition, 2016-10-01),

ISO : 14001:2015 (Environmental Management System)

ISO : 50001:2018 (Energy Management System)

SILCA LIBRARY

This catalogue updates and completes the information regarding all the vehicle keys produced by Minda Silca. If you would like to keep your catalogues always updated, visit www.mindasilca.in and www.silca.biz. Every month you can find out what new keys have been produced by consulting the “Silca News” Bulletins.

ELECTRONIC KEY CATALOGUE

Silca also makes its electronic catalogue available to you, also on your smartphone. The Silca electronic catalogue will be updated in real time with all the new keys making it the ideal assistant for all office activities, the management of stock references, automatic creation of orders, printing packing lists and much more.

KEY IDENTIFICATION

Keys are drawn to a 1:1 scale. Identification of a key can be made by laying the key on the drawing, paying particular attention to the blade and profile. Alternative head shapes are indicated by images around the standard head.



Transponder Information



An electronic chip with a non-volatile memory which contains an ELECTRONIC CODE. The transponder has an antenna with which it can interface with an external electronic control device. Through the antenna the device emits a fixed frequency signal; the transponder receives the signal and then transmits its electronic code, by means of special modulation techniques, to the control device, which is able to process the code. The transponder has no external input of power supply (passive system): it receives the energy necessary to work from the signal emitted the external control device (inductive coupling between the control device antenna and that of the transponder).

IMMOBILIZER

An electronic antitheft system which interfaces with the engine control device, and often also with the starter, that allows the engine to start only when the electronic code in the transponder is recognized.

Symbology



FIXED ELECTRONIC CODE

Each key has a different electronic code. The code are fixed alphanumeric code(they are not rewritten when the engine is started).



ROLLING CODE

Each key has different electronic code. However, the codes are changed every time the key is used to start the vehicles engine. The procedure by which the code is changed is known only to the manufacturer of the immobilizer and is difficult to deduce by reading the transponder memory in the key.



CRYPTO CODE

The Crypto Code represents the latest generation of transponders and immobilizer systems (introducing bi-directional encryption of data). Internal protected algorithms will be configured to interpret the alternative messages changing at each cycle



MINDA SILCA ELECTRONIC KEY

Electronic Card (with battery) that emulates the function of the Texas[®] Fix code type Transponder (4C) and Crypto Type Transponder and Philips[®] Crypto Type(46)

Transponder Replacement

TRANSPONDER REPLACEMENT (ONLY FOR MINDA SILCA KEYS)

it may be necessary to remove the Transponder due to an incorrect procedure or key-cutting error. If so, follow the instructions given below, according to the type of key:

- Key with a single plug (e.g. GT15RT2) : push out the plug through the hole in the lower part of the head, using a paper clip or preferably the accessory illustrated (fig. 1). Replace the Transponder and fit the plug in place.
- Key with a pair of plugs (e.g. HU66AT5): perforate the point shown in (fig.2). until the two plugs separate. Fit the Transponder and seal with two new plugs.
- Key with two shells (e.g. TOY43T2): starting from the point shown in (fig.3). separate the two shells with a flat screwdriver Fit the Transponder and re-assemble the key.

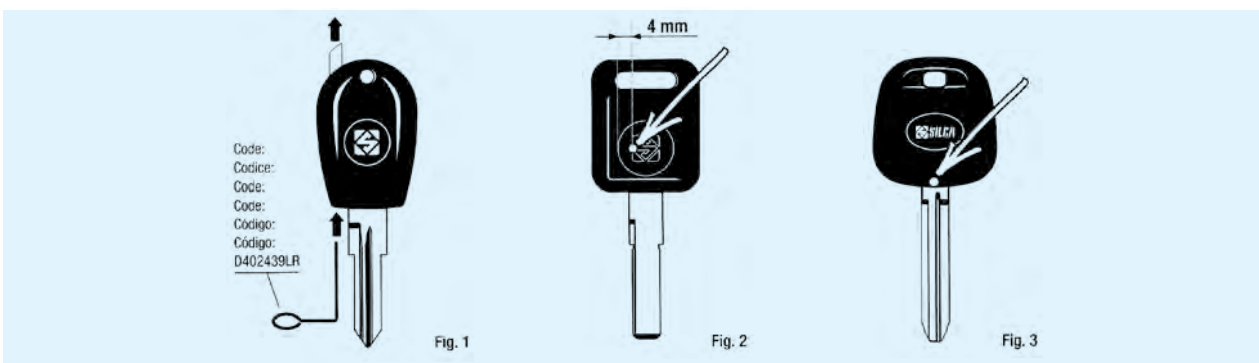

Silca offers a wide range of transponders enabling you to copy over 90% of vehicle keys available in market

Transponder Technology

Sophisticated software and data base are developed and dedicated to program and reproduce electronic automotive keys.

Silca has developed a special product range continuously updated with new electronic keys and transponder devices. Each new car model launched in the market represents Silca new keys, new softwares and devices to be engineered and produced.

Silca Software

The Silca Software Programs have become the standard language of the Professional Locksmiths.

Silca has always developed and produced in house the software upgrades specifically designed for its products. The data gathering from the four corners of the world has granted to the company, the possibility to make available to the Locksmiths - innovative software programs, relevant data base and info on each single key in the market.

After Sale Assistance

Continuous product updates and collection of relevant info from the market place guarantees Silca's clients to be always updated with the latest info and hence support customers in their every day job by a number of Assistance Centers, operating closest to the shops in the territory.

Name	Type Of Transponder	ID	Material
T3	Texas® Fixed Code	ID4C	Glass
T4	Texas® Fixed Code	ID4C	Carbon
T5	Temic®, Philips® and Megamos® Fixed Code	ID23	Carbon
T6	Megamos® Crypto	ID48-A	Glass
T7	Texas® Crypto	ID60	Glass
T8	Texas® Crypto Chrysler - Renault®	ID64	Carbon
T9	Philips® Crypto Opel®	ID40	Carbon
T10	Philips® Crypto VAG®	ID42	Carbon
T12	Philips® Crypto Opel®	ID40	Carbon
T13	Texas® Crypto Nissan® - Subaru®	ID60	Carbon
T14	Philips® Crypto 2	ID46	Carbon
T16	Texas® Crypto	ID60	Carbon
T17	Texas® Crypto Ford®	ID63	Carbon
T18	Texas® Crypto Mitsubishi®	ID65	Carbon
T19	Texas® Crypto Suzuki®	ID61	Carbon
T20	Texas® Crypto 3	ID6A-60	Carbon
T21	Texas® Crypto Subaru® - Mitsubishi®	ID62	Carbon
T22	Texas® Crypto Yamaha®	ID69	Carbon
T23	Megamos® Crypto Seat®	ID48-A3	Glass
T24	Megamos® Crypto Volkswagen®	ID48-A1	Glass
T25	Philips® Crypto Nissan®	ID41	Carbon
T26	Megamos® Crypto Skoda®	ID48-A4	Glass
T27	Sokimat® Crypto	ID8E	Glass
T28	Philips® Crypto Volkswagen®	ID4W	Carbon
T29	Philips® Crypto Peugeot®	ID45	Carbon
T30	Philips® Crypto Mitsubishi®	ID4M	Carbon
T31	Texas® Crypto Toyota®	ID67	Carbon
T32	Philips® Crypto 2 Chrysler® - Renault®	ID46	Carbon
T33	Megamos® Crypto Writable	ID48-A	Glass
T34	Megamos® Crypto - Audi®	ID48-A	Carbon
T39	Texas® Crypto DST80 Hyundai® & Kia®	IDF-60	Carbon
T41+	Texas® Crypto DST80 - Ford®	IDF-60	Carbon
T48	Megamos® Crypto Writable for Silca ID48 Solution	ID48-A	Glass
T80+	Texas® 80 Bit Ford®, Toyota®, Hyundai® & Kia®	ID63	Carbon
T128C	Texas® 128 Bit Toyota® H Type & Subaru®	ID7A-39 & ID7A-17	Carbon

SILCA ID 49 SOLUTION

Silca ID49 Solution

The first worldwide solution for cloning NXP Hitag® 3 transponders for Honda®

Silca ID49 is the only solution available on the market for cloning ID49 transponders used on certain Honda® models manufactured from 2014. The solution

allows to duplicate a wide range of keys easily identified by the letter 'G' engraved on the blade and equipped with a 96 bit NXP Hitag® transponder.

GTI PRO & UTX-S TRANSPONDERS

The new multifunction transponders for cloning and programming the most common original car and motorbike keys

GTI PRO and UTX-S are the new Silca multi-transponders with a wide technology coverage to reduce the customer inventory. They are compatible with the existing Silca GTI-Wedge, T80+, ID8C, T49C, T128C, T5. These new multifunction transponders are for cloning and programming the most common original car and

motorbike keys. These two new transponders offer faster cloning and programming functionalities and being small in size, allows for greater versatility of use. In fact, it is compatible with the entire range of Silca vehicle keys and with the majority of original car and motorbike keys.

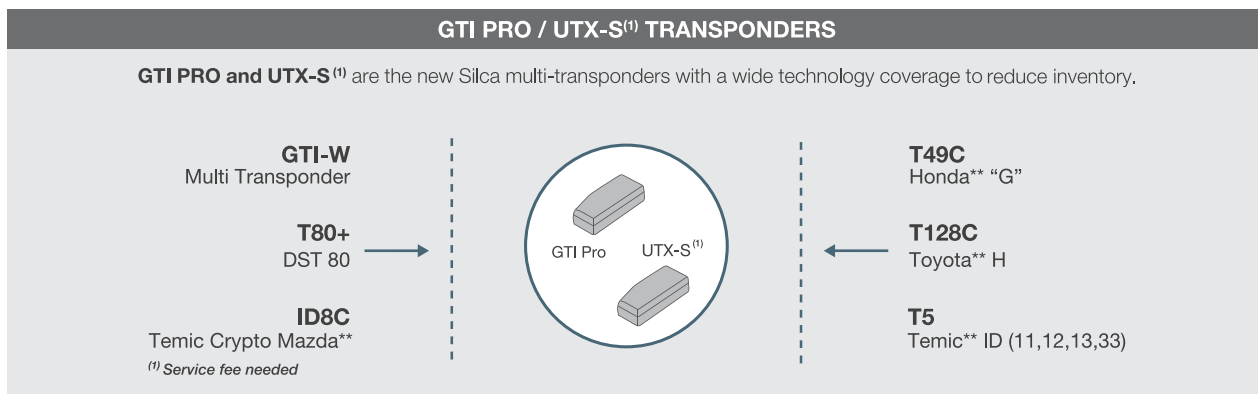

TOYOTA® "H" Solution-128C

Toyota* 'H' Solution

The exclusive cloning solution for Texas* 128 bit transponders for Toyota*

The Toyota* 'H' Solution allows you to clone Texas* 128 bit transponders for Toyota* models using 'H' type keys. You can also pre-set the transponder used on several Toyota* and Subaru* models for programming with a diagnostic

Free software update for RW4 Plus and Fast Copy Plus

With the Toyota* 'H' Solution you can clone the transponders of the most recent and popular Toyota* models using an 'H' type key by simply employing in stand alone mode the Silca RW4 Plus and Fast Copy Plus. You just have to update your device to the 04.08.093 version. The software update is free of charge.

Compatible with Silca keys

The Toyota* 'H' Solution is compatible with the Silca Look A-like, MH-TA and Flip keys, and with original vehicle keys.

Pre-setting available for programming the transponder

With the Toyota* 'H' Solution you can preset the transponder used on some Toyota* and Subaru* models, so that you can program it later with the Smart Pro device.

Familiar process

You can clone 128 bit transponders in exactly the, familiar way you clone other transponders.

No need to operate inside the car

The transponder can be cloned without the need to connect with the vehicle via a 'snoop' device making the process easier and more streamlined. No internet connection is required to complete the process

Transponder T128C Main Application		
- Cloning for Toyota* - Programming for Toyota* (🇯🇵 ID7A-39 - T128T) - Programming for Subaru* (🇯🇵 ID7A-17 - T128S)	The transponder can be pre-set for programming with a diagnostic device directly from the RW4 Plus key-board. Once pre-set, the transponder can no longer be used for cloning.	The Toyota* 'H' Solution has been designed and manufactured in conformity with CE mark European standards.



RW5

Cloud Cloning Solution

Silca RW5 is the fast, easy solution able to duplicate transponders for around 99% of cloneable vehicle keys in circulation, including ID46 and ID48.

Cloning calculations are made using Silca proprietary servers to guarantee reliability, ensuring that the latest routines are always available and time-consuming software updates are avoided.

The cloning process is guided step by step via a colour display with procedures up to 3 times faster than available devices. Full integration with the MYKEYS Pro ecosystem gives support and information across the entire vehicle key duplication process helping to deliver the best solution to the customer.

CLONING PROCESS



SMART Aerial+ Cloud Cloning Solution

The Smart Aerial+ from Advanced Diagnostics simplifies and speeds the key cloning process.

Cloning calculations are made using Advanced Diagnostics proprietary servers to guarantee reliability, ensuring that the latest routines are always available and time-consuming software updates are avoided.

Smart Aerial+ works hand in hand with the MYKEYS Pro app to guide the user through the entire cloning process, providing all the necessary information needed to deliver a perfect duplicate key.

CLONING PROCESS



(**) In compliance with current regulations relating to industrial property, please note that - but for "Silca", "domakakaba", "Kaba", "Iico" and "Advanced Diagnostics" - the trademarks or trade names mentioned in our document are the exclusive property of third parties not affiliated nor linked with Silca S.p.A. or the dormantakaba Group. Silca S.p.A. and dormantakaba Group do not own any intellectual property right nor have been granted any license with regard to such trademarks and trade names, which are hereby used only to indicate the intended purpose of Silca's products. This procedure is reserved exclusively for professional key cutters who use Silca products. The illustrations and technical data regarding the products in the document are to be considered indicative. Silca reserves the right to alter products designs, dimensions or info to improve the products quality. The contents of this document are fully protected by Copyright and may not be copied or reproduced in any form, without written permission from Silca S.p.A. Any controversy shall be settled by the Courts where the company Silca S.p.A. has its headquarters, with express exclusion of any other court.



TWO WHEELER KEYS



Two Wheelers Keys



FOR BAJAJ



T7004
CALIBER

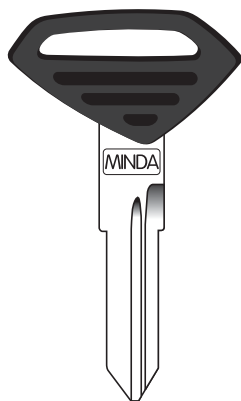

T7005
PULSAR
(SMALL)

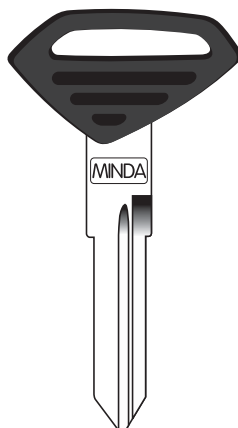

T7017
DISCOVER

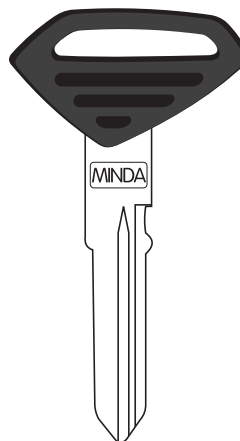

T7251
DISCOVER

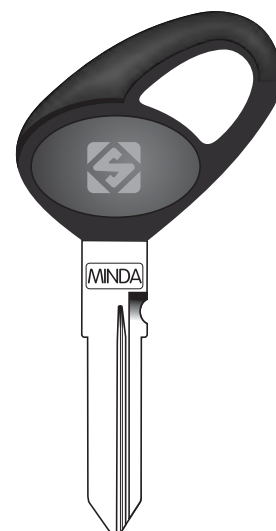

T7023
CT-100

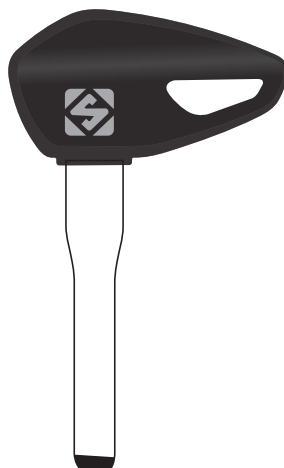

T7163
PULSAR 180

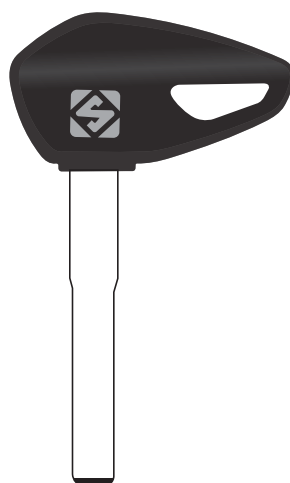

T7318
PULSAR 180
(ULTRALITE BLADE)

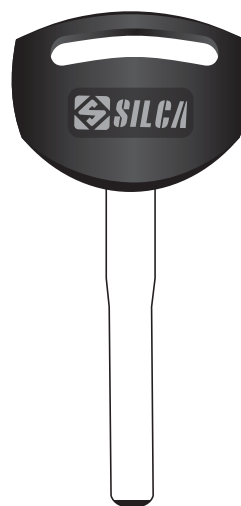

T7098
PULSAR 220

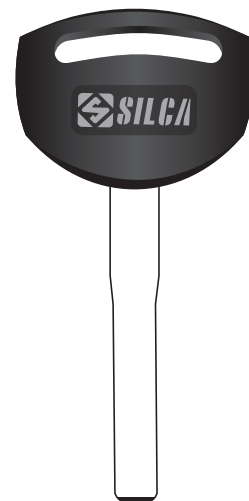

T7319
PULSAR 220
(ULTRALITE BLADE)



T7029
SCOOTER

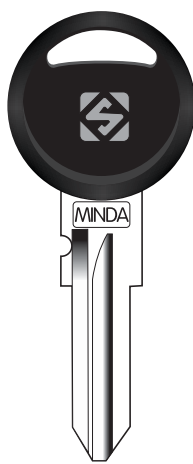

T8178
PAWNA

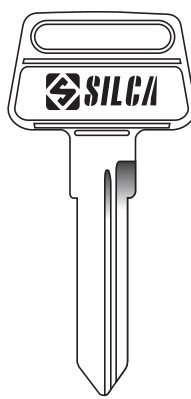

T7064
AVENGER



T7062
ELIMINATOR

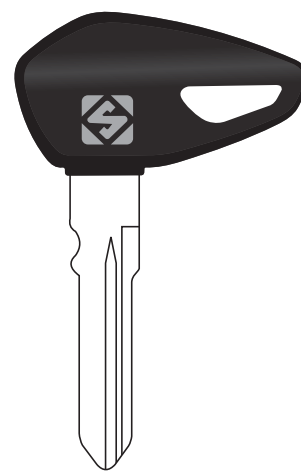

T7277
PULSAR (NEW)

Two Wheelers Keys

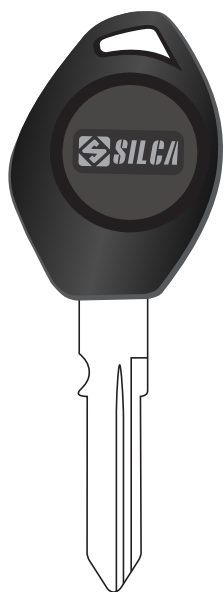

CBAJ3P20
V 15
(MINDA)



T7223
V 15
(MINDA)

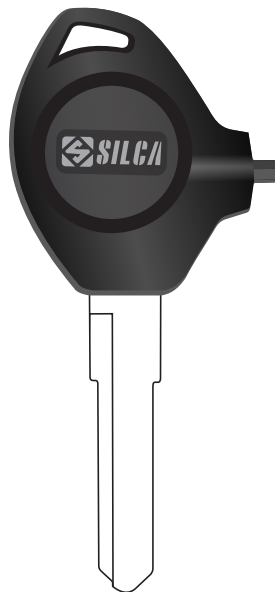

T7278
V 15
(PAWNA)



T7249
AVENGER FLG

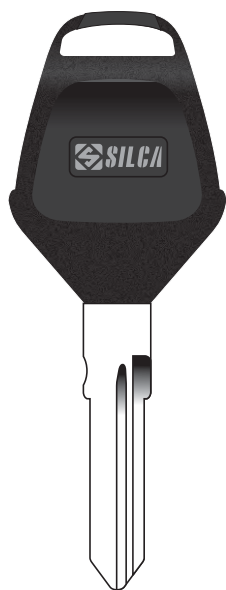

T7164
DISCOVER
(NEW)

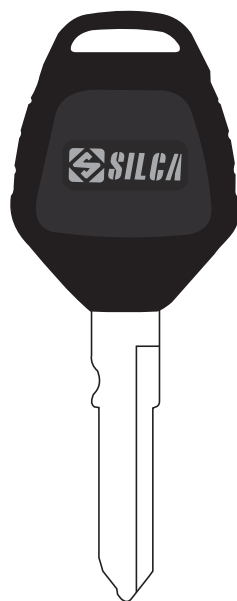

A1003Z
DISCOVER
(SINGLE LINE)

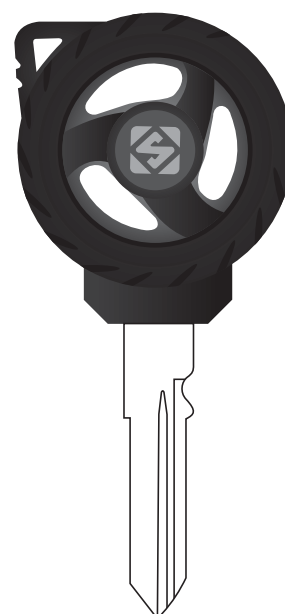

T7444
DISCOVER
(TYRE TYPE)

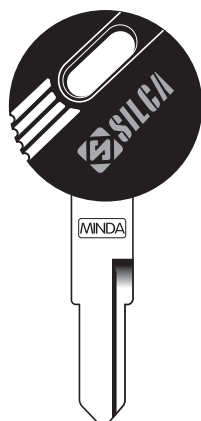

T7065
BAJAJ AUTO
(OLD)



T7090
BAJAJ 06 MODEL

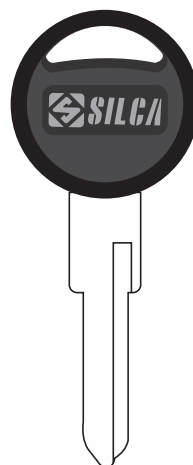

T7284
BAJAJ AUTO
(NEW)

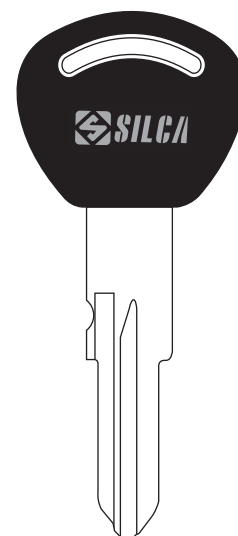

T7378
PIAGGIO AUTO

FOR BAJAJ

FOR BAJAJ / PIAGGIO (3 WHEELER)

Two Wheelers Keys



FOR HERO MOTOCORP

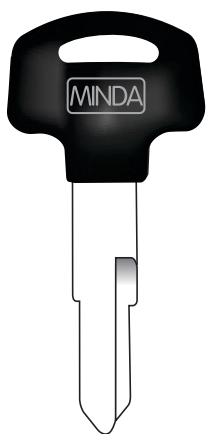

T7093
SPLENDOR-R
(SMALL)

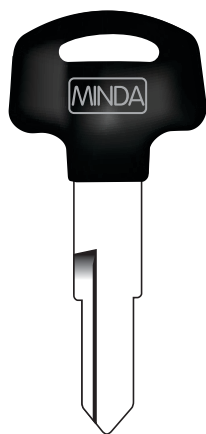

T7094
SPLENDOR-L
(SMALL)

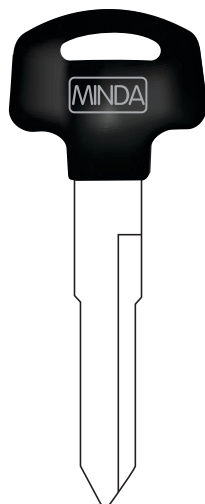

T7103
SPLENDOR-R

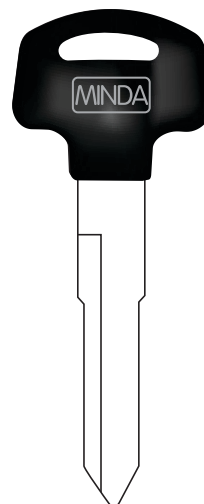

T7104
SPLENDOR-L

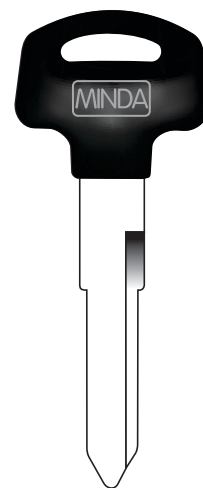

T7095
SPLENDOR-L
(BIG)

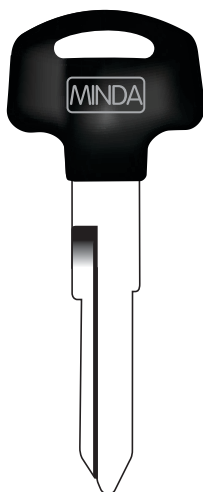

T7096
SPLENDOR-R
(BIG)

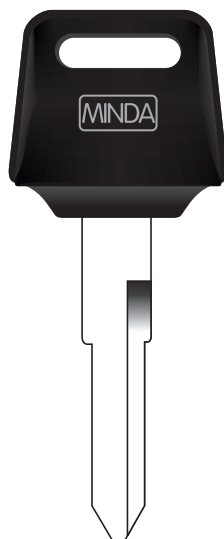

T7111
AMBITION-L



T7112
AMBITION-R

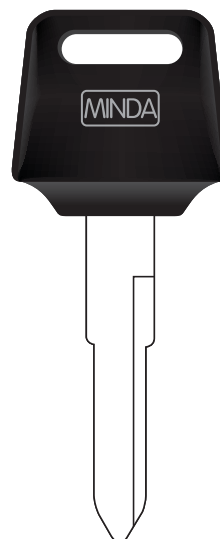

T7113
AMBITION-L

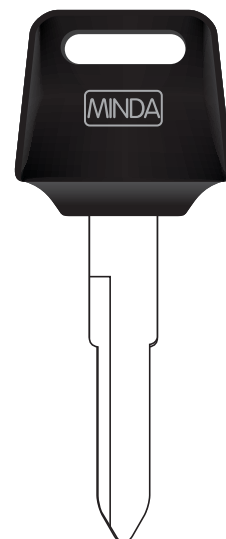

T7114
AMBITION-R



T7037
PASSION PLUS
(MINDA)

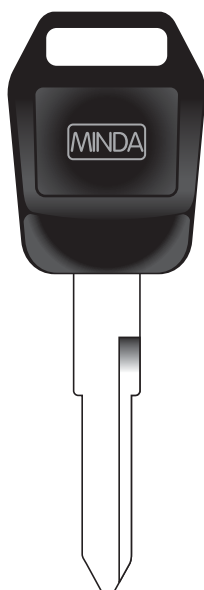

T7151
PASSION PRO-L



T7152
PASSION PRO-R

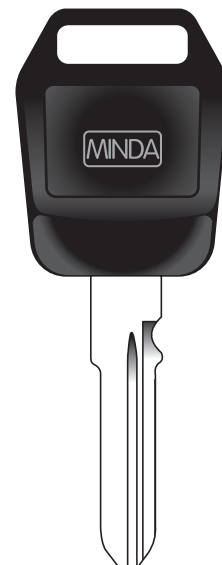

T7268
SPLENDOR
(AFTERMARKET)

Two Wheelers Keys

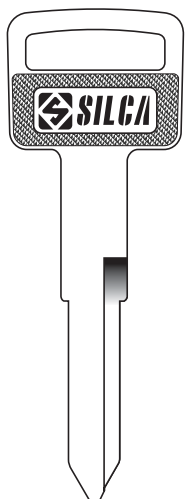

CHON42
AMBITION-L

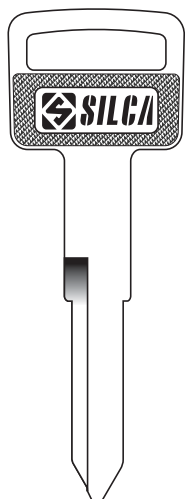

CHON42R
AMBITION-R

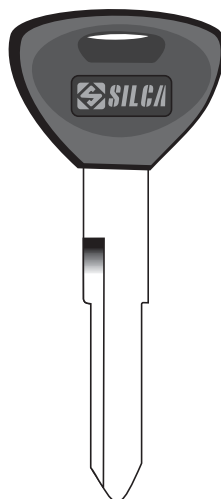

CHRO1RP
NXG-R

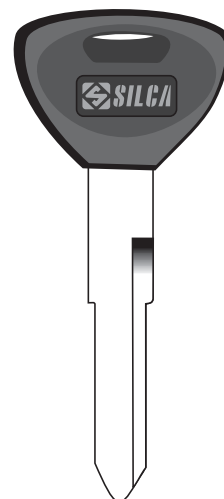

CHRO1P
NXG-L



CHR03RP20
DESTINI



CHR03P20
DESTINI

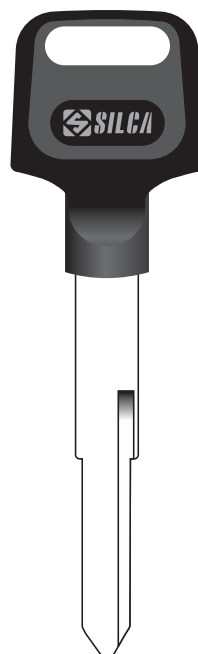

CHON72P
CBZ XTREME

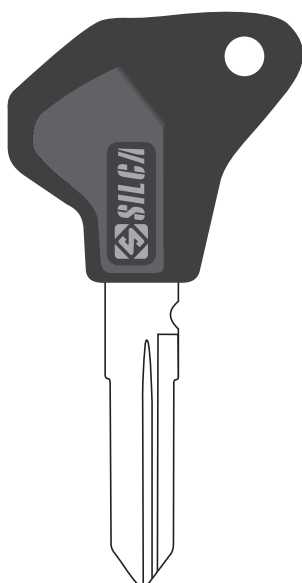

CHR02P20
HERO-L (NEW)

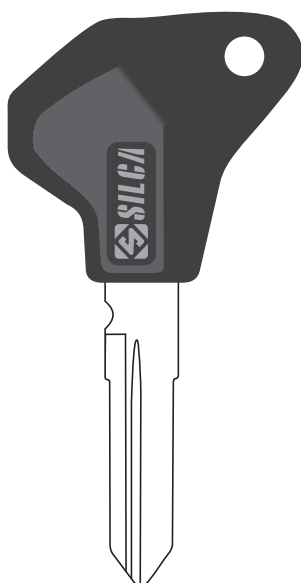

CHR02RP20
HERO-R (NEW)

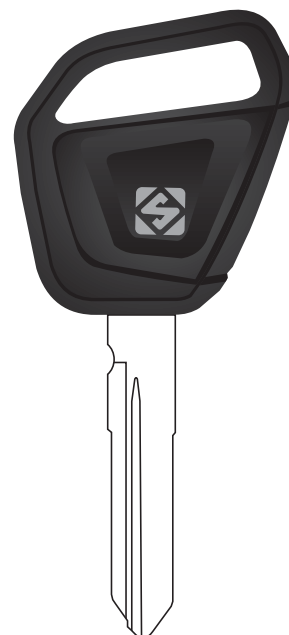

A1309LZ
MAESTRO

Two Wheelers Keys



FOR HERO MOTOCORP

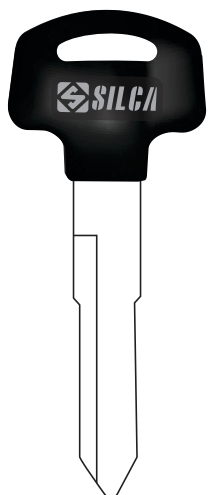

A15003DLZ
SPLENDOR-L

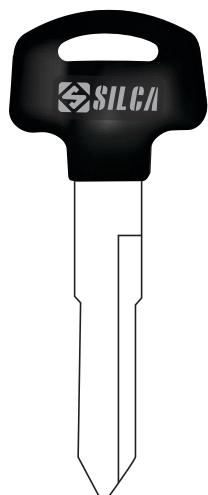

A15003DRZ
SPLENDOR-R

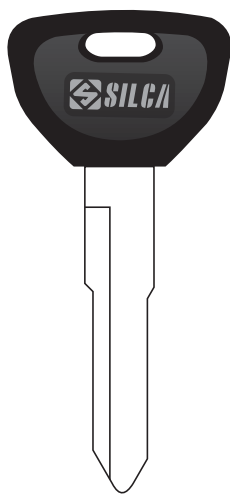

A15001CLZ
NXG-L

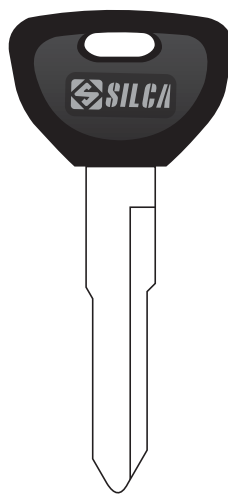

A15001CRZ
NXG-R

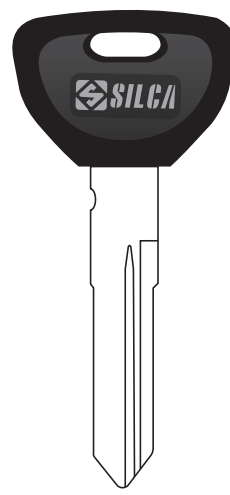

T7366
NXG
(NEW)

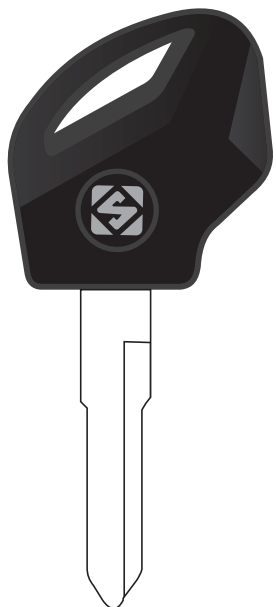

T7414
GLAMOUR

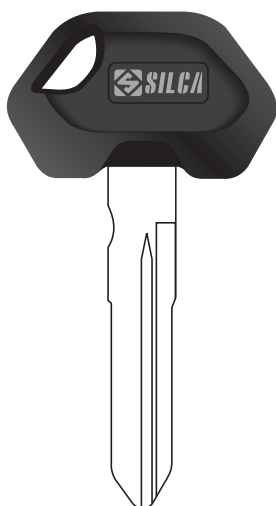

T7286
DUET-R

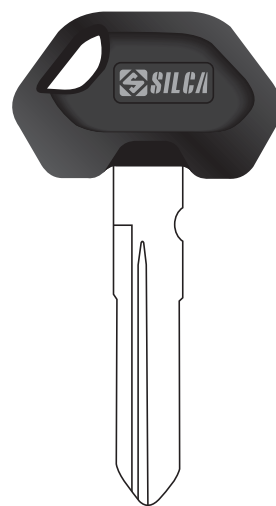

A1309ALZ
DUET-L

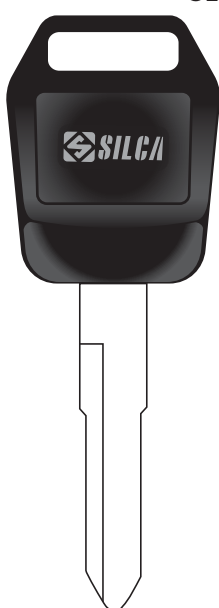

A15001FLZ
PASSION PRO-L

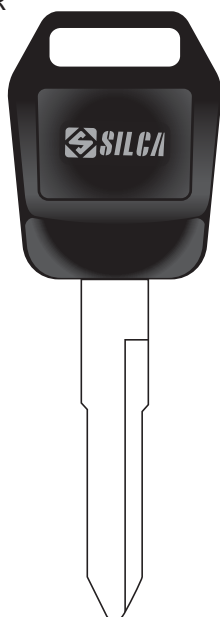

A15001FRZ
PASSION PRO-R

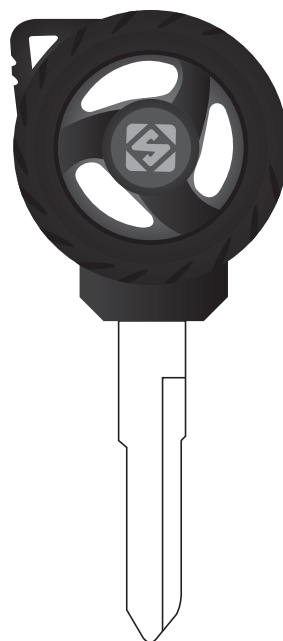

T7447
SPLENDOR / PASSION-R
(TYRE TYPE)

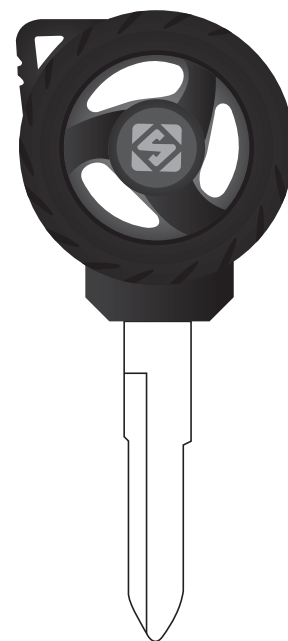

T7448
SPLENDOR / PASSION-L
(TYRE TYPE)

Two Wheelers Keys



FOR HONDA

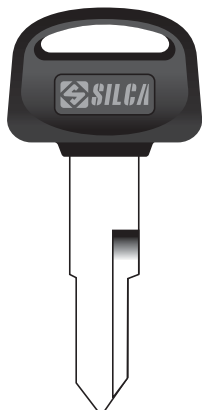

T7105
ETERNO-L
(SMALL)



T7106
ETERNO-R
(SMALL)



T7010
ACTIVA-L
(MINDA)



T7009
ACTIVA-R
(MINDA)



T7069
ACTIVA
(OLD)

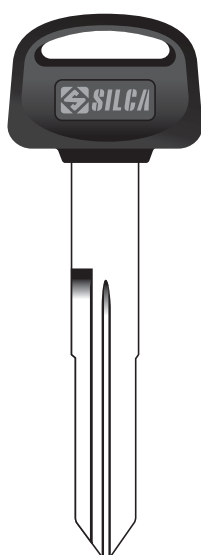

T7136
ACTIVA
(EXTRA LONG)

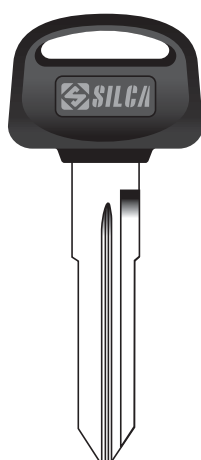

T7133
ACTIVA-L
(LONG)

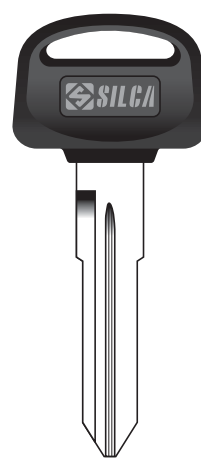

T7107
ACTIVA-R
(LONG)

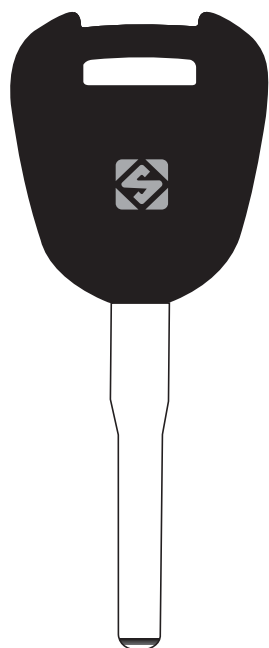

T7417
H'NESS (LASER)

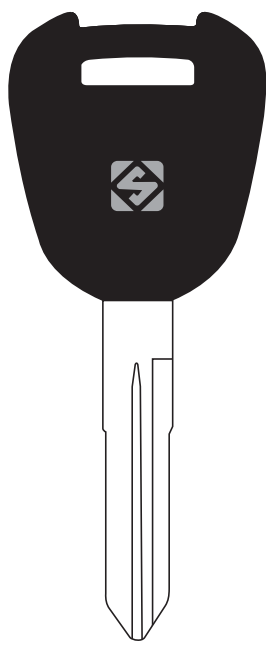

T7415
H'NESS 350

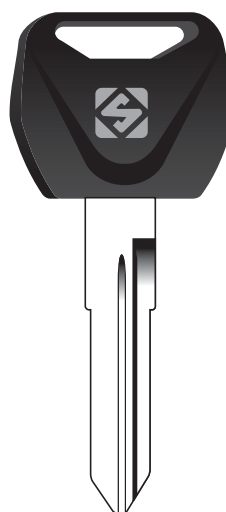

T7108
UNICORN-L

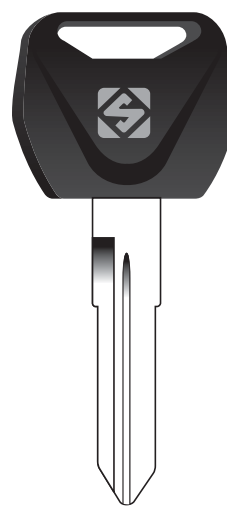

T7134
UNICORN-R

Two Wheelers Keys



FOR HONDA

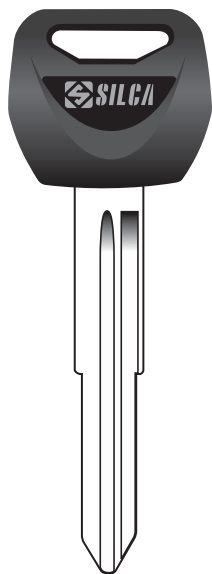

CHON63FP
CBR

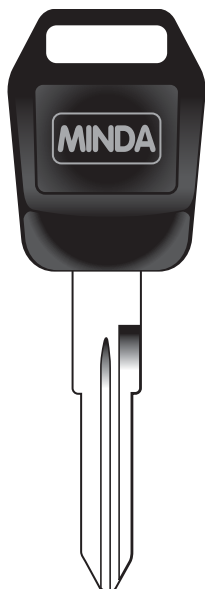

T7162
SHINE

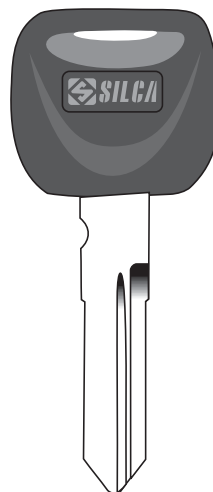

T7193
TWISTER

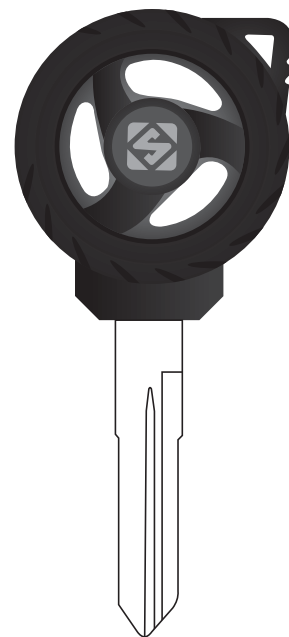

T7449
UNICORN
(TYRE TYPE)

FOR KAWASAKI / LOHIA / APRILIA / VESPA

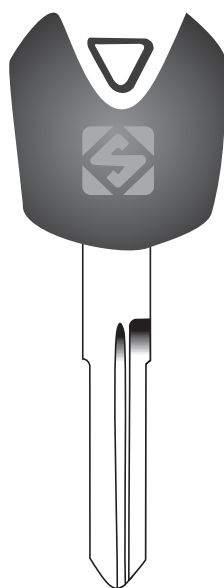

T8269
NINJA



T7007
BOXER

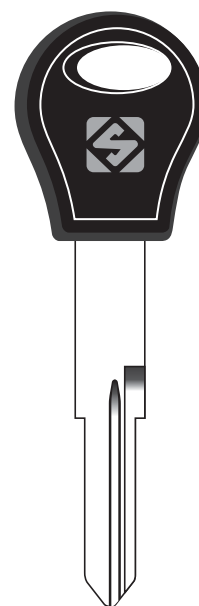

T7142
OMASTAR

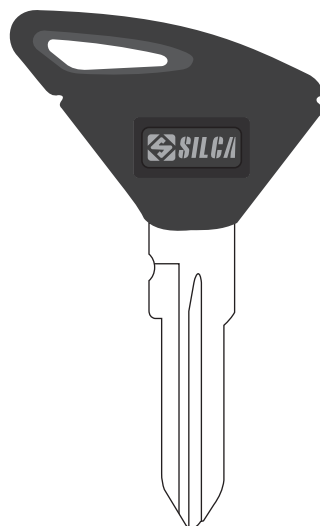

T7244
APRILIA

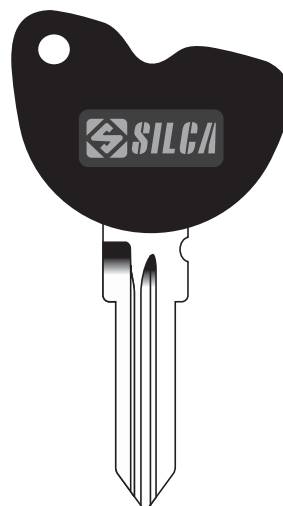

T7159
VESPA

Two Wheelers Keys

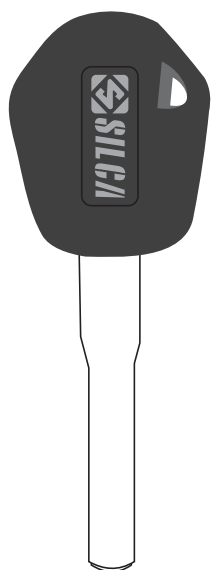

T7247
DUKE

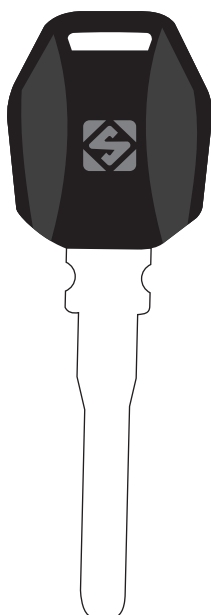

A1248TZ
DUKE

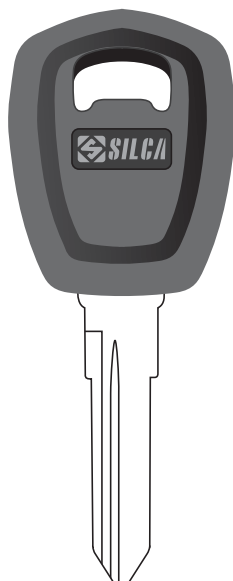

ML-10127
HARLEY DAVIDSON



T7110
BULLET-L



T7119
BULLET-R



T7160
ENFIELD-L
(LONG)



T7161
ENFIELD-R
(LONG)

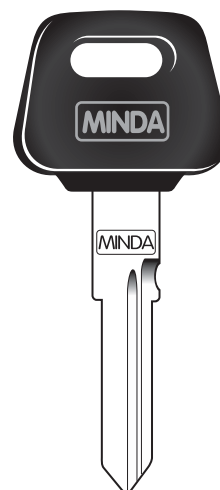

T7057
ENFIELD
(MINDA)

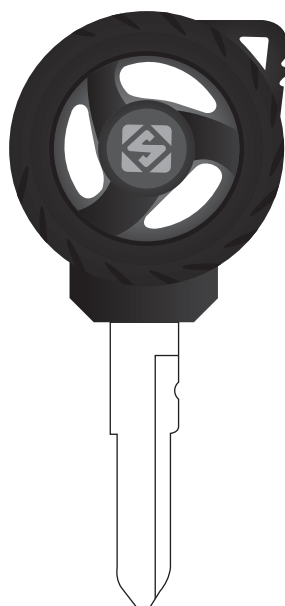

T7443
CLASSIC 350-R
(TYRE TYPE)

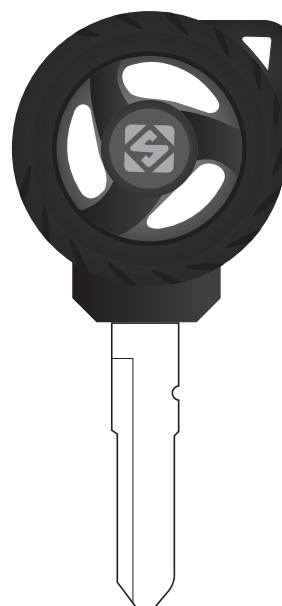

T7442
CLASSIC 350-L
(TYRE TYPE)

FOR KTM / HARLEY DAVIDSON /
ROYAL ENFIELD

FOR ROYAL ENFIELD

Two Wheelers Keys



FOR ROYAL ENFIELD

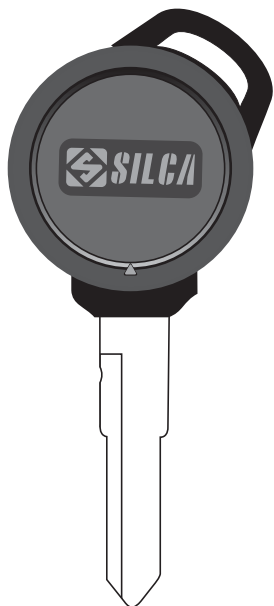

T7271
CLASSIC 350-R

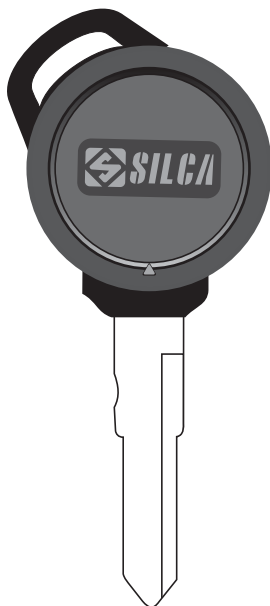

T7272
CLASSIC 350-L

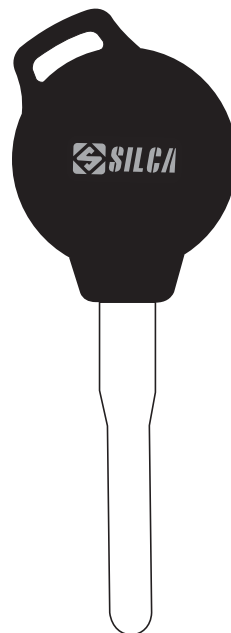

A1002Z
INTERCEPTOR 650

FOR KINETIC

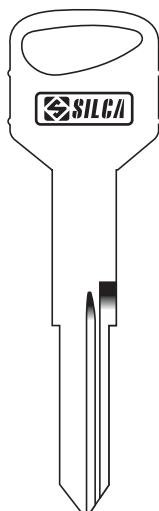

T7123
FLYTE



T7031
NOVA



T7006
ZING-R



T7016
ZING-L

FOR LML / MAHINDRA

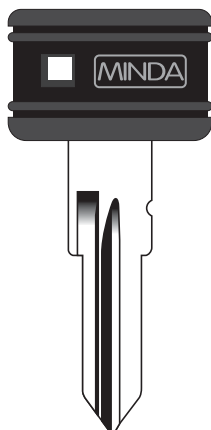

T7124
NV

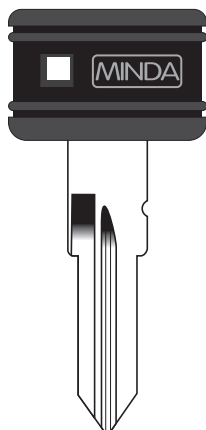

T7014
SCOOTER

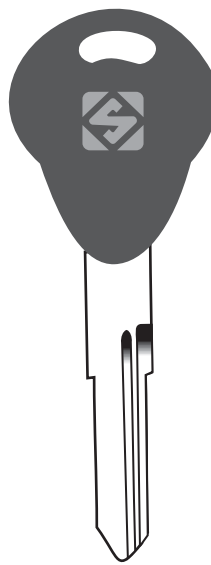

T7243
GUSTO

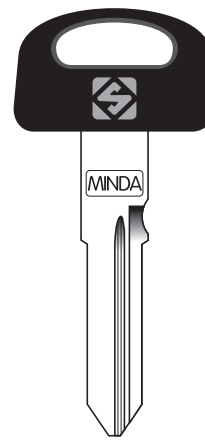

T7141
RODEO

Two Wheelers Keys



FOR TVS

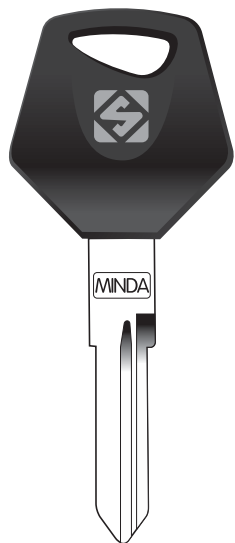

T7001
VICTOR
(MINDA)

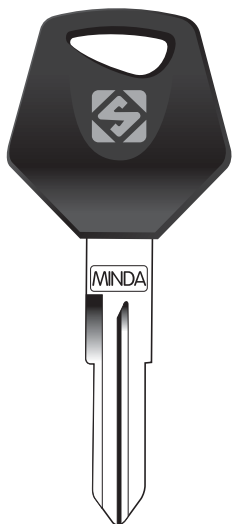

T7074
VICTOR



T7109
CENTRA-L



T7121
CENTRA-R

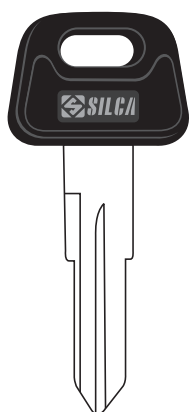

T7130
SPORTS

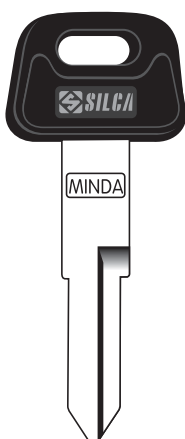

T7129
SCOOTY PEP
(NEW)



T7008
SCOOTY PEP

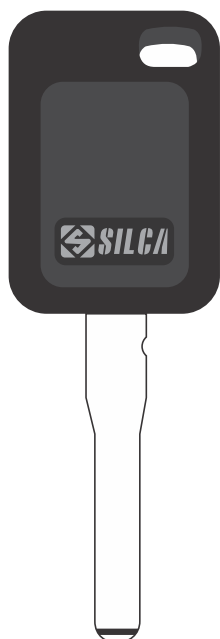

A1296DZ
iQUBE (EV)

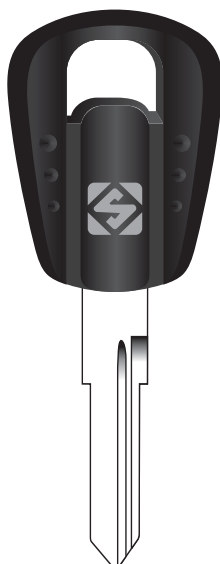

T7143
WEGO

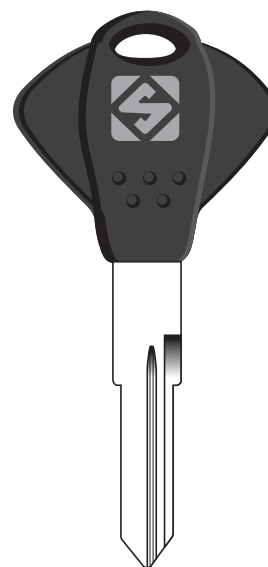

T7099
FLAME

Two Wheelers Keys

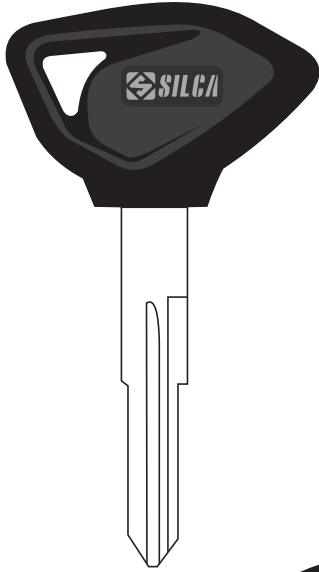

T7299
APACHE-R

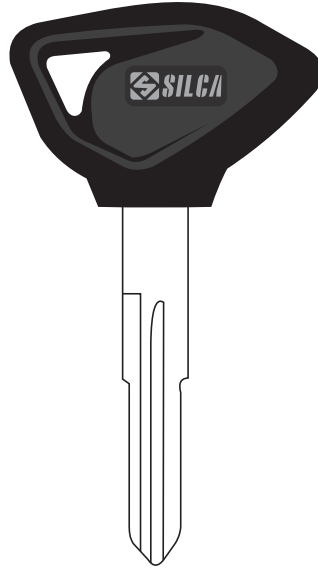

T7289
APACHE-L

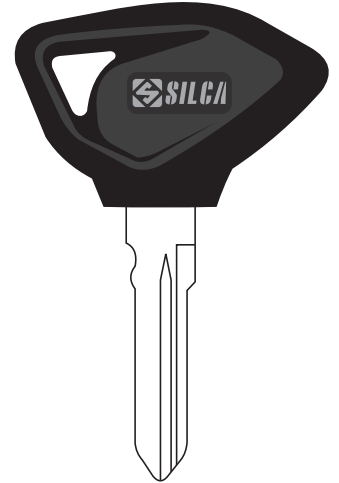

T7273
APACHE
(AFTERMARKET)

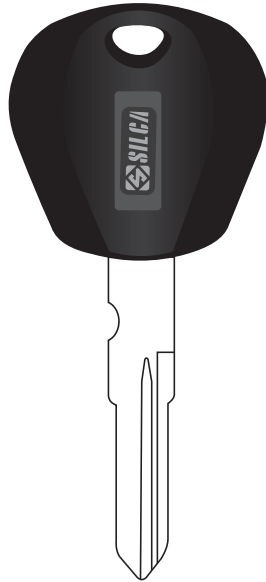

T7320
JUPITER (BS6)

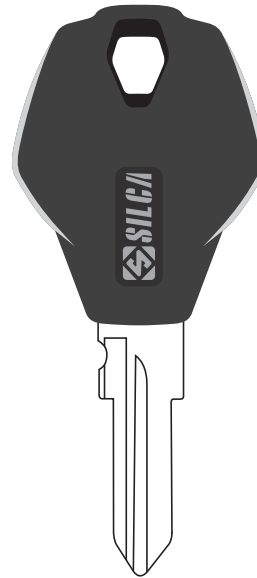

A1306Z
APACHE (NEW)



T7315
APACHE 200

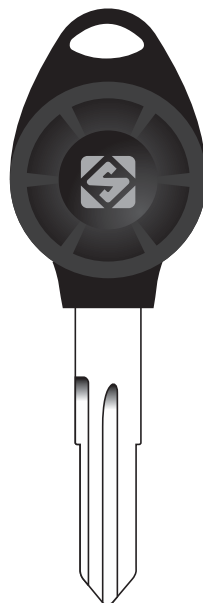

T7144
APACHE

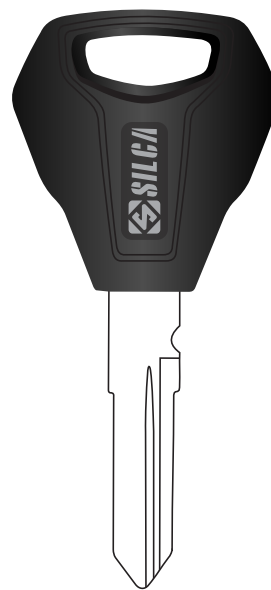

CTVS3P20
APACHE

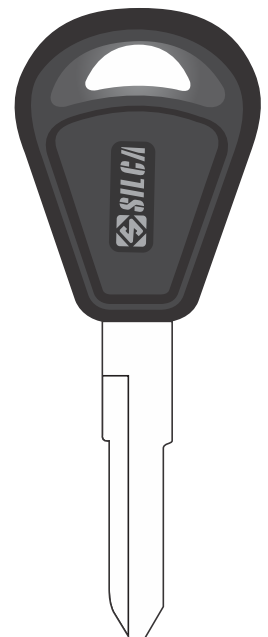

T7455
RADEON-L

Two Wheelers Keys

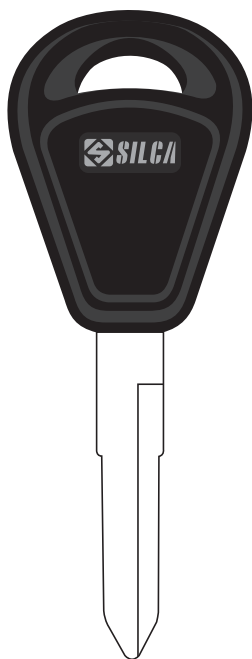

T 7300
RADEON-R

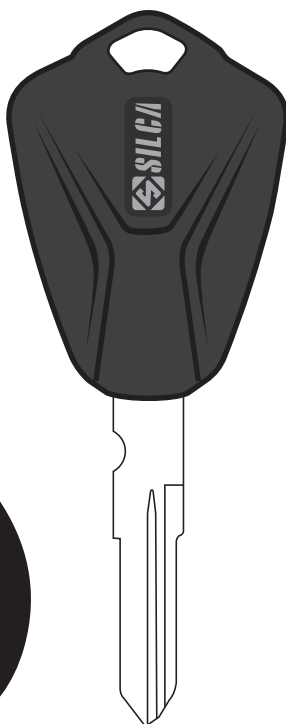

A1296GZ
NTORQ

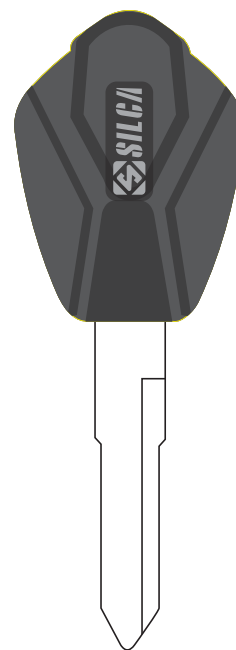

T7280
NTORQ
(NEW)

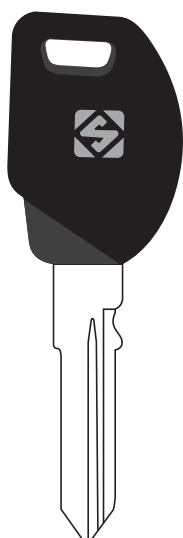

A0112WZ
XL100

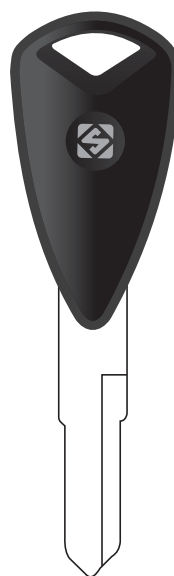

T7412
STREAK



T7100
ZEUS-R

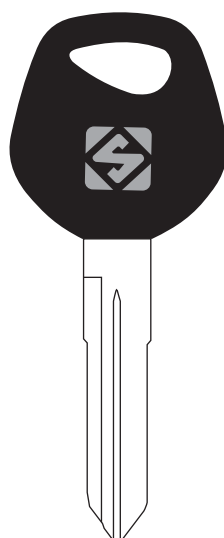

T7386
ZEUS

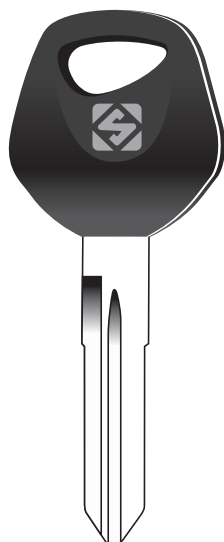

T7157
ZEUS-L

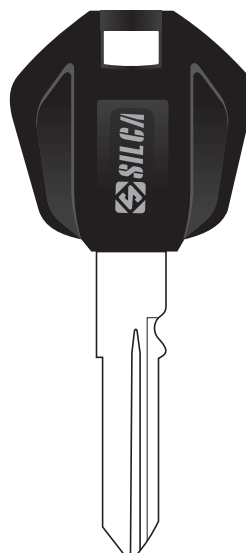

T7316
GIXXER SF 250



T7225
GIXXER

FOR TVS

FOR SUZUKI

Two Wheelers Keys



FOR YAMAHA



T7024
FAZER

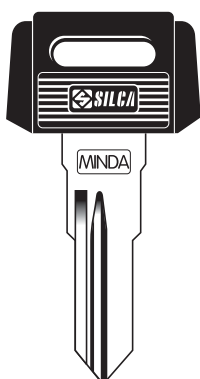

T7002
YBX



T7003
RX100



T7011
ENTICER

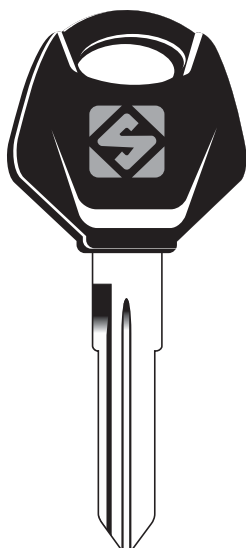

T7158
SZ

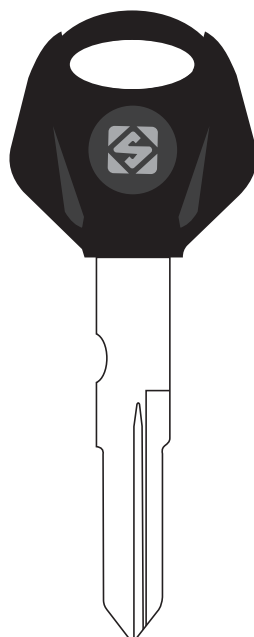

A1302CZ
FZ

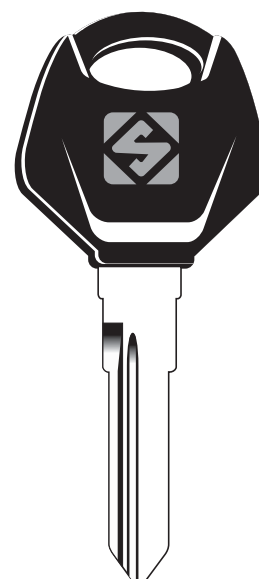

T7120
R15

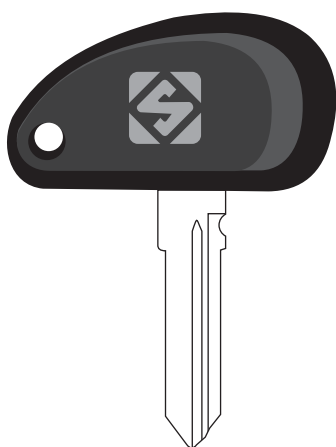

A0139FZ
JAWA

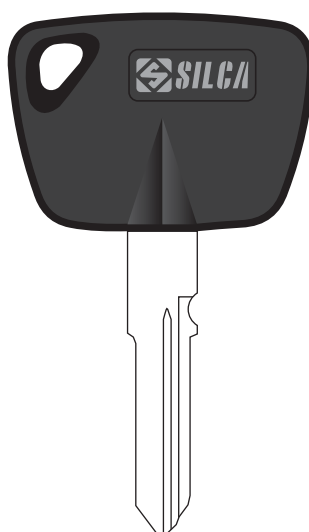

A16003AZ
YEZDI

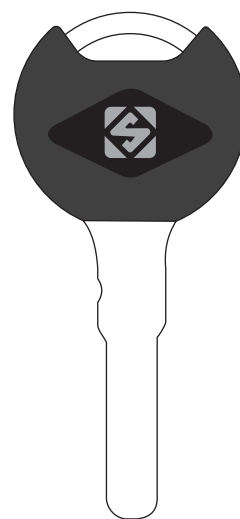

A1010Z
EV REVOLT

FOR JAWA / YEZDI / REVOLT

Two Wheelers Keys



T7156
ACTIVA 3G

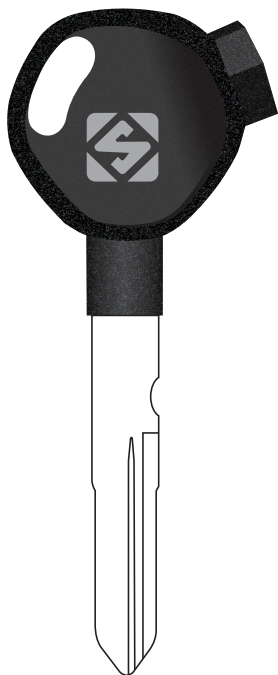

A1291GZ
ACTIVA 5G
(SPARK MINDA)



T7188
ACTIVA
(MINDA)

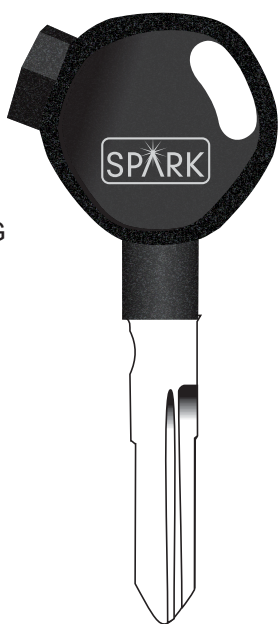

T7192
ACTIVA
(SPARK MINDA)

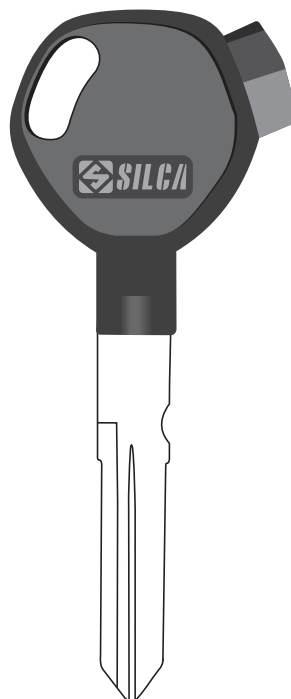

A1017Z (T7276)
ACTIVA 5G

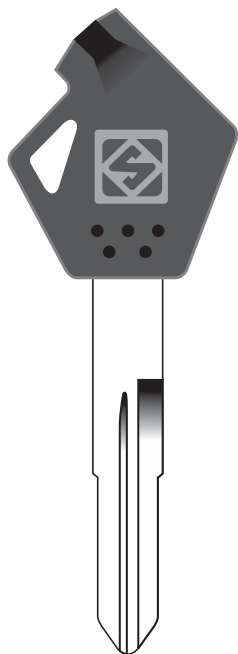

T7169
ACCESS
(OLD)

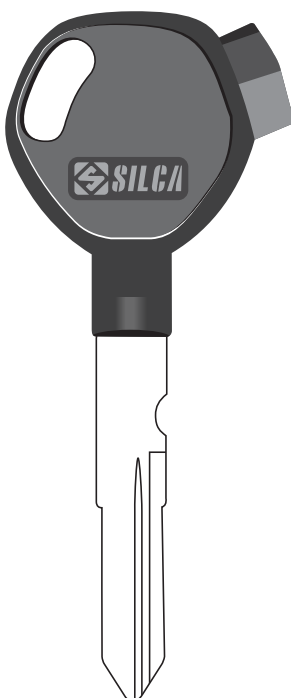

A1018Z (CHON78P)
GRAZIA

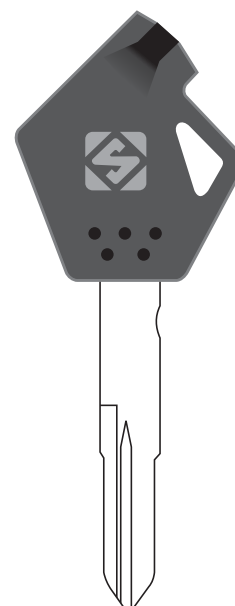

T7185
ACCESS-L

Two Wheelers Keys



MAGNETIC KEYS

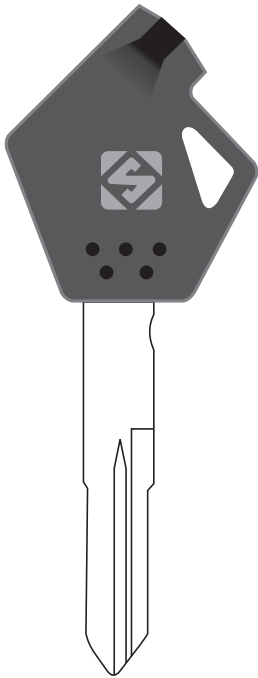

T7263
ACCESS
(NEW)

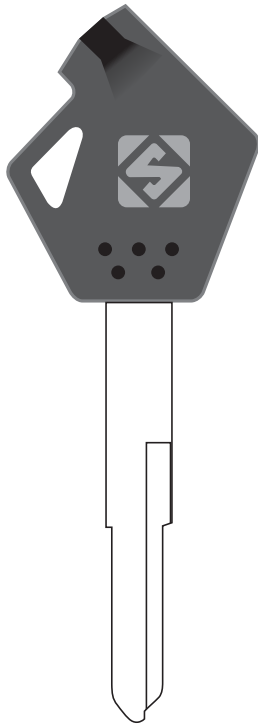

T7283
ACCESS 125CC

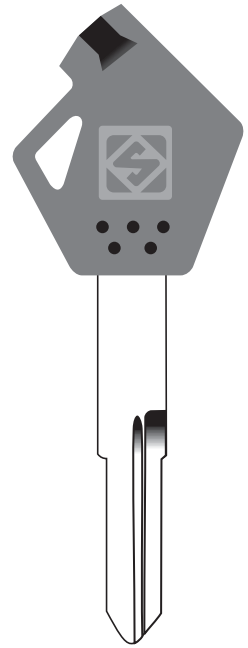

T7189
SWISH



T7191
JUPITER

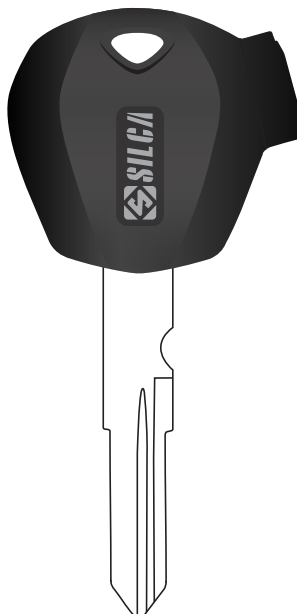

CTVS2P20
JUPITER

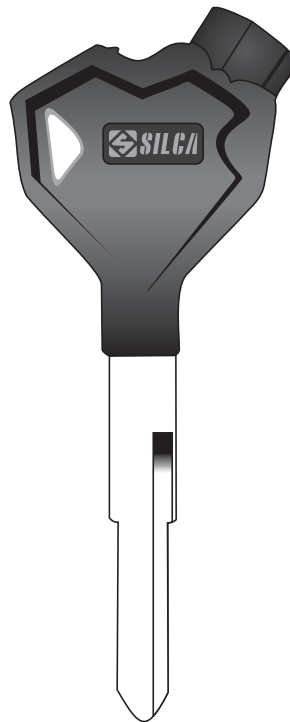

CHON74P
CBZ XTREME

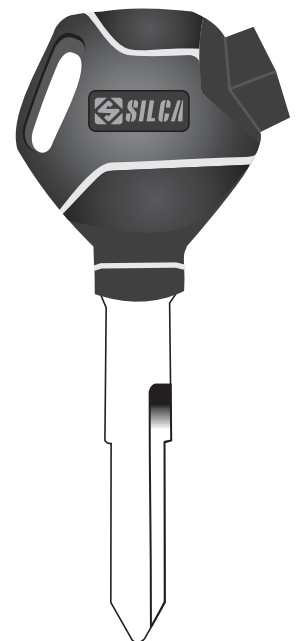

T7175
MAESTRO

Two Wheelers Keys

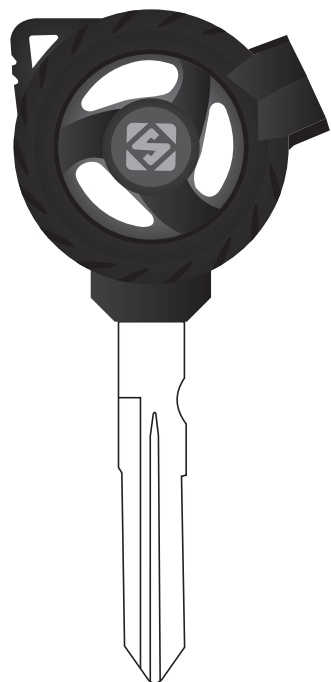

T7416
ACTIVA 3G

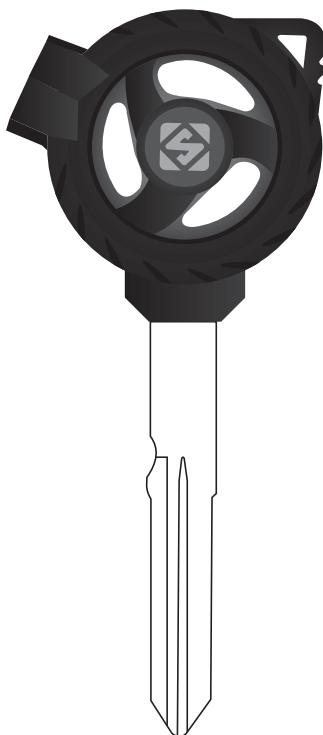

T7430
ACTIVA 5G

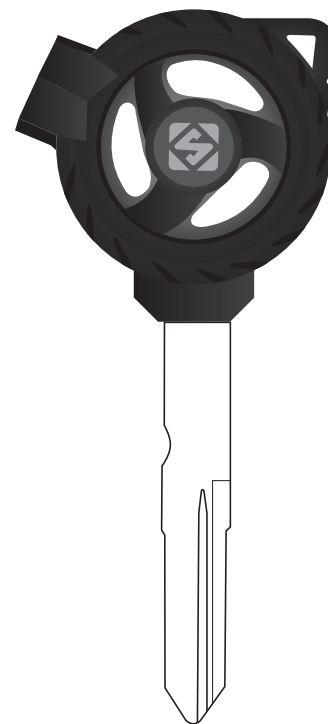

T7431
GRAZIA

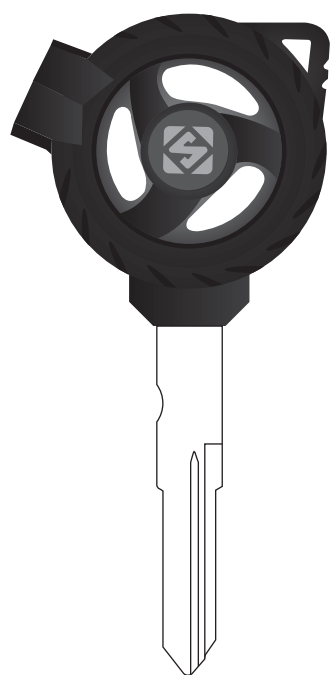

T7429
ACTIVA (MINDA)

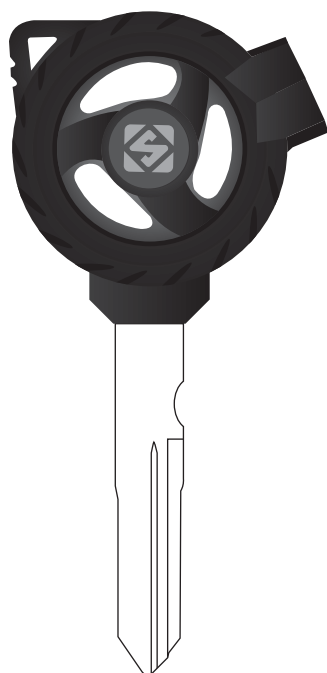

T7428
ACTIVA (MINDA)

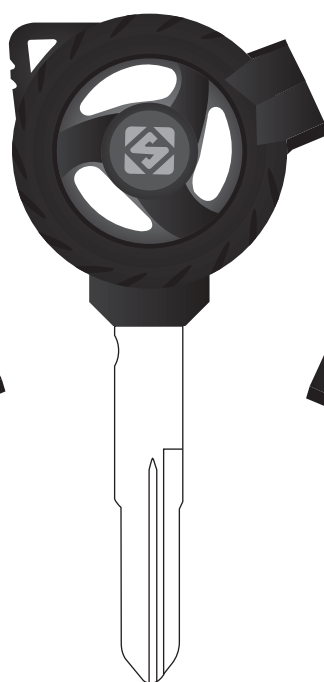

T7440
ACCESS

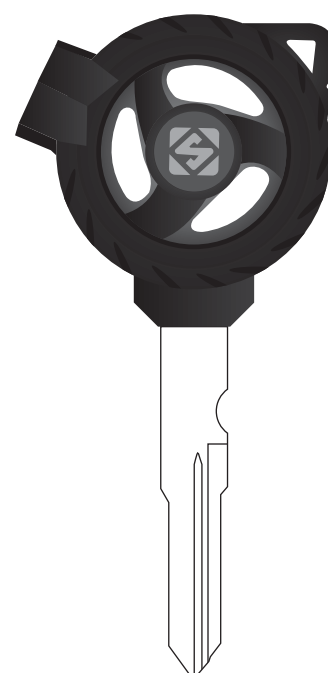

T7439
JUPITER

MAGNETIC KEYS (TYRE HEAD)

Two Wheelers Keys



NON MAGNETIC KEYS

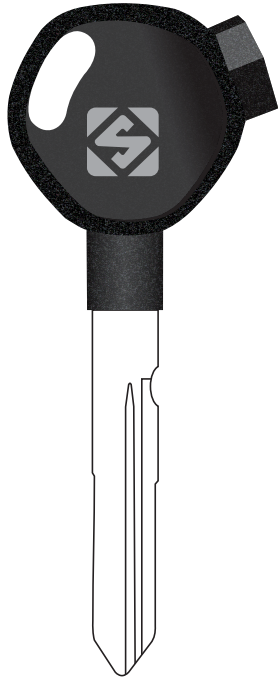

T7340
GRAZIA

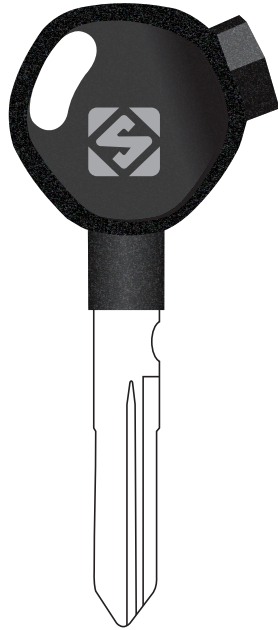

T7345
ACTIVA 3G

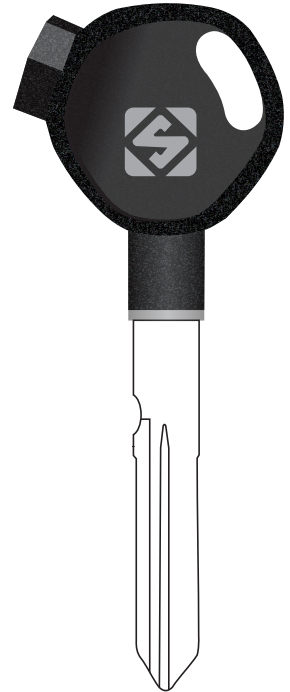

T7341
ACTIVA 5G

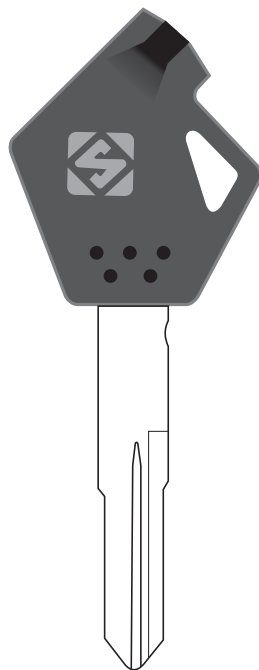

A1285Z
ACCESS



T7344
JUPITER

Two Wheelers Keys

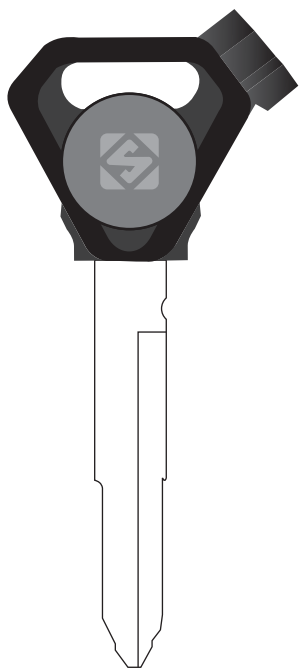

A1013Z
SLAZ-L

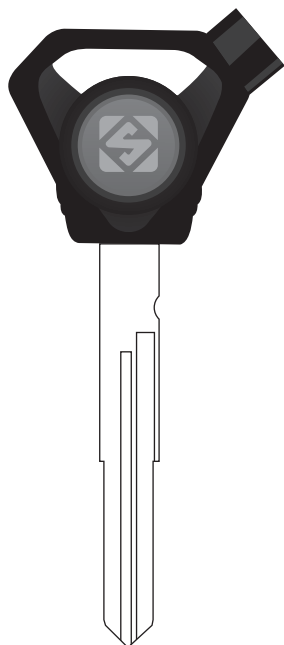

A1014Z
FZ / MIO

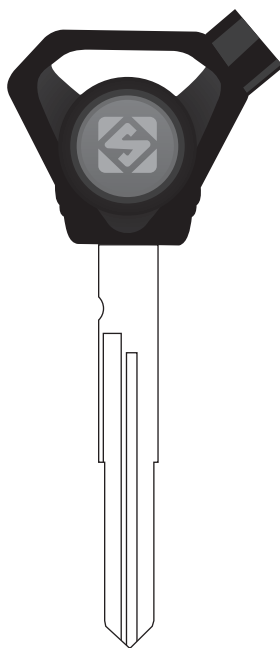

A1015Z

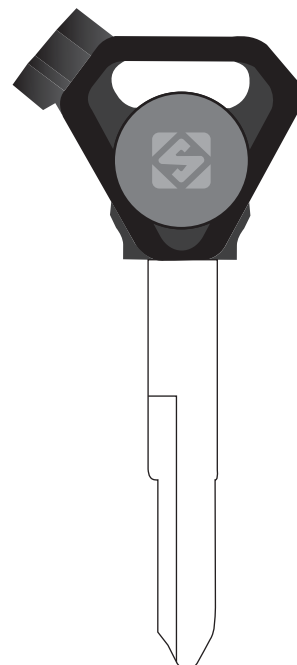

A1001Z
SLAZ-R

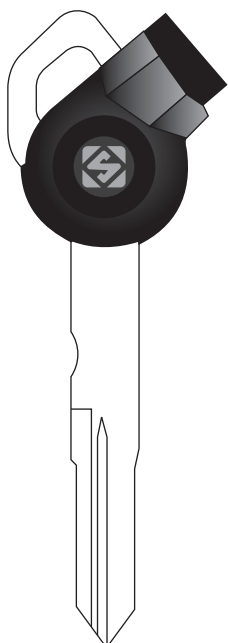

A1032Z
NMAX 155

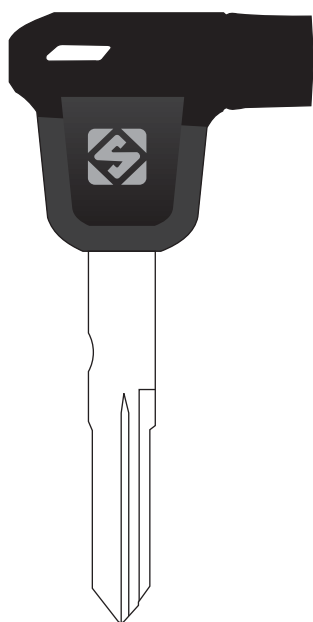

A10191
GSX 150

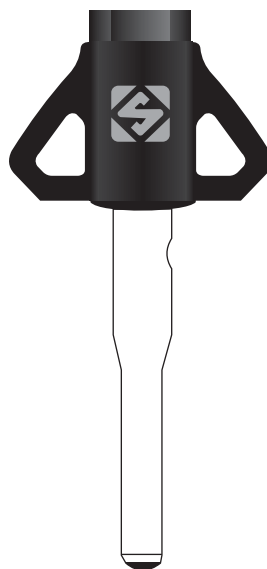

A1286FZ
R-15

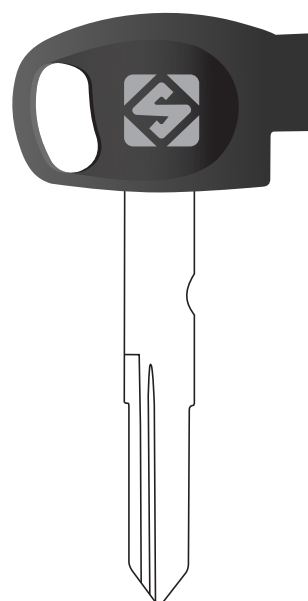

T7260
FASCINO

Two Wheelers Keys



SOUTH EAST ASIA - MAGNETIC KEYS

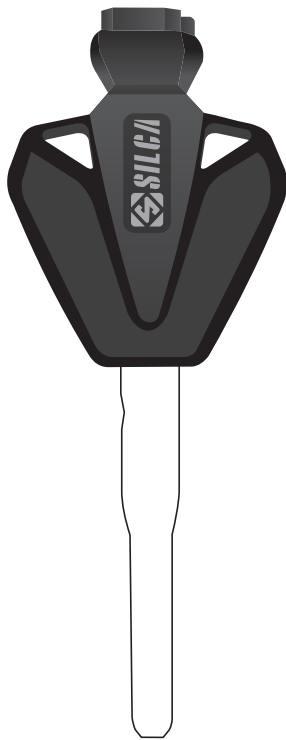

T7261
X-ABRE / M-SLAZ

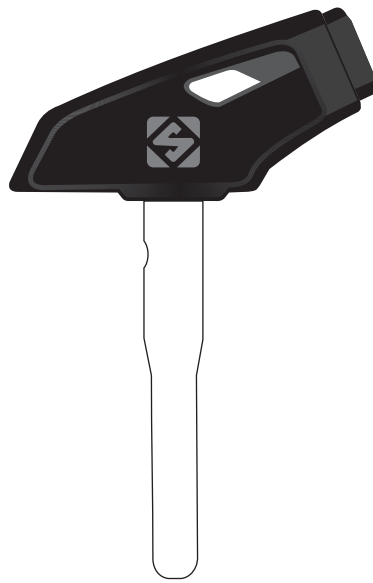

T7257
R-15

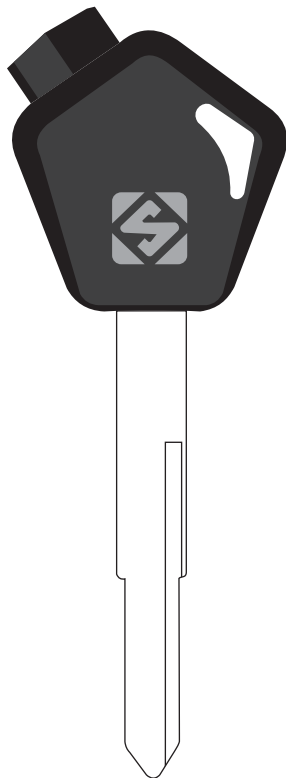

A7172
WAVE

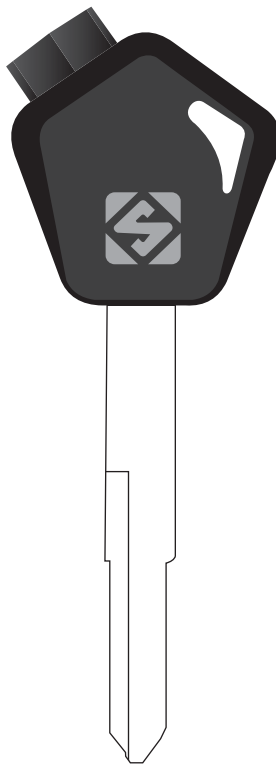

A1012Z

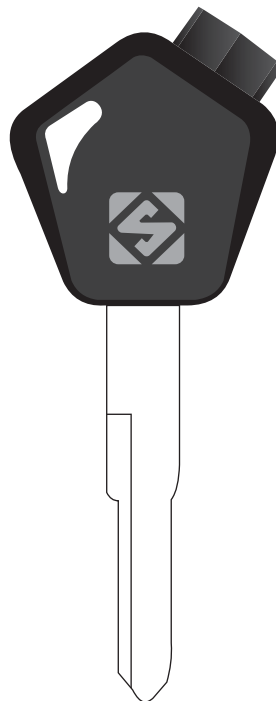

A1011Z
Wave 110i-L

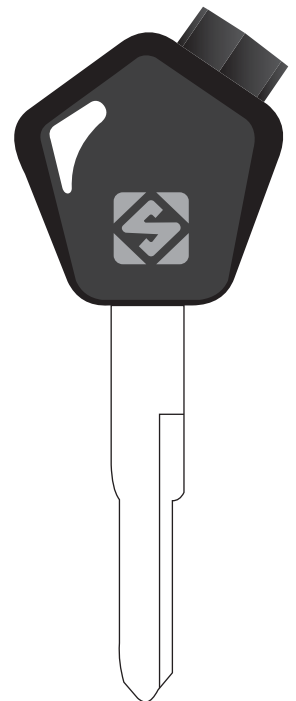

A1041Z
Wave 110i-R



FOUR WHEELER KEYS

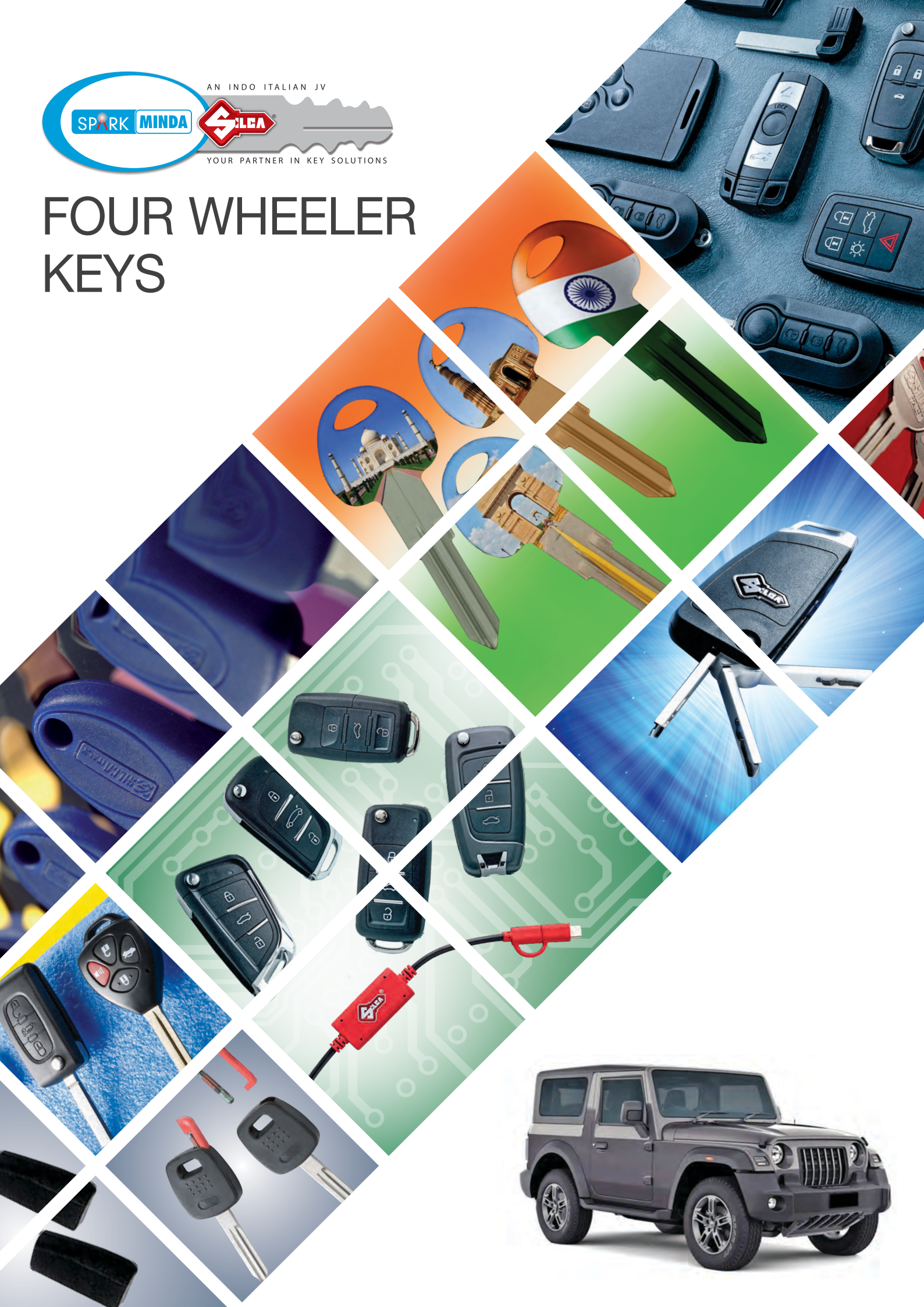

Four Wheelers Keys



FOR DAEWOO / FIAT



T7032
CIELO

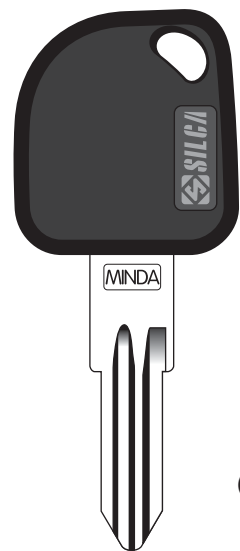

T7036
MATIZ

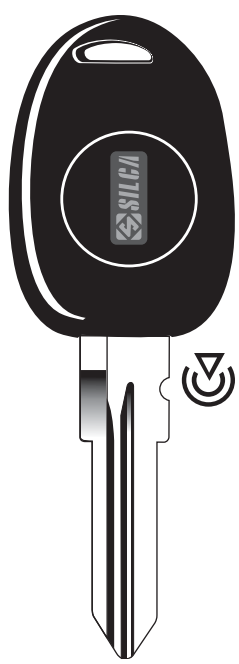

T7040
PALIO
(WITH TRANSPONDER)

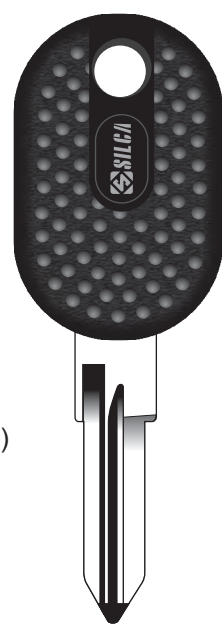

T8008
UNO

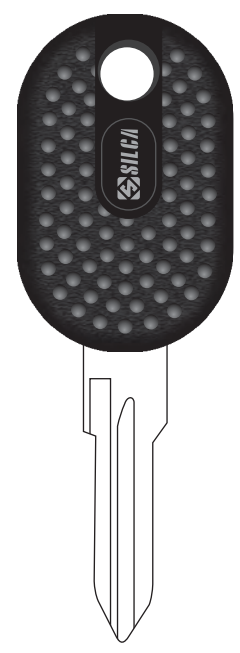

T8084
GT10

FOR FORD



T7076
FIESTA

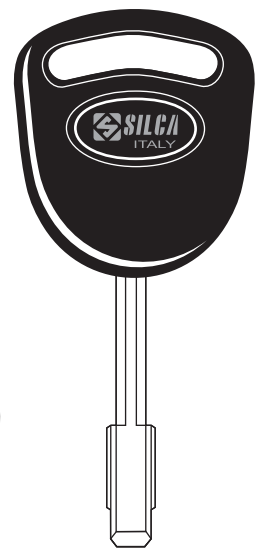

FO2IP
IKON

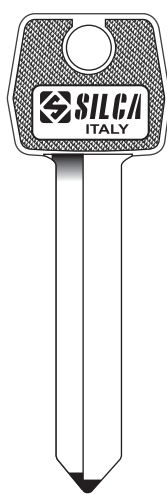

FO26
ENDEAVOUR

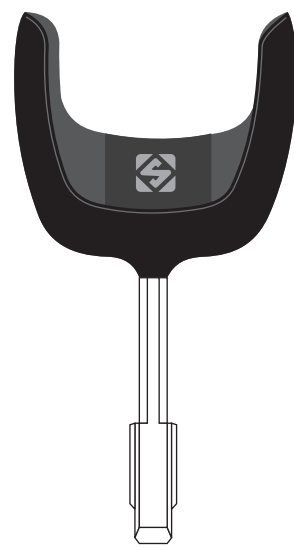

FO21AP
REMOTE BLADE

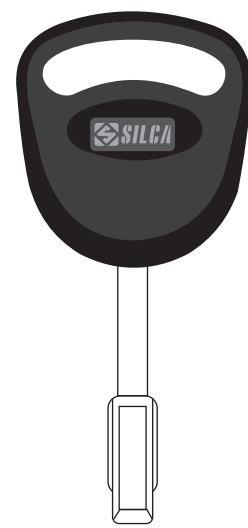

T7184
FIESTA

Four Wheelers Keys

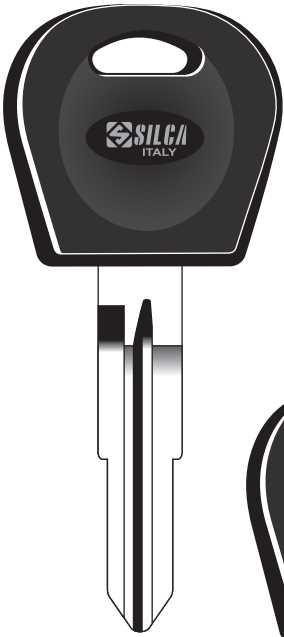

DWO5RAP
AVEO

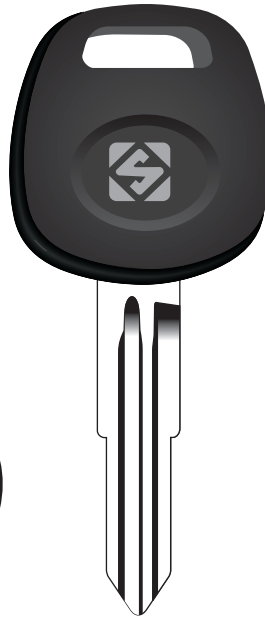

T7116
SPARK

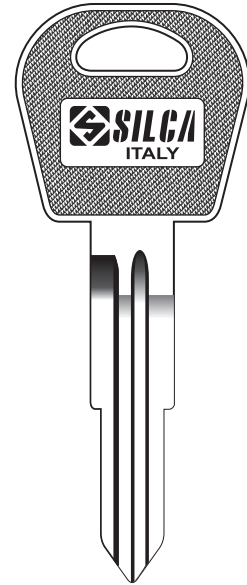

DWO4R
OPTRA

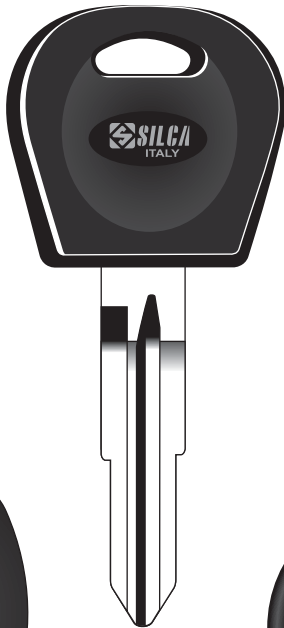

DWO4RAP
OPTRA

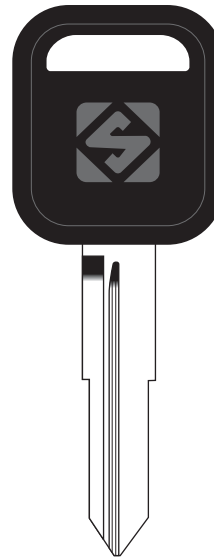

T7018
TAVERA

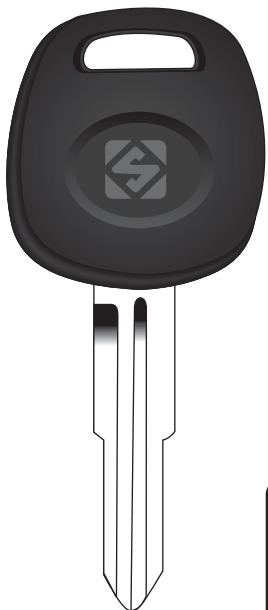

T7187
AVEO



WT7AP
VOLKSWAGEN

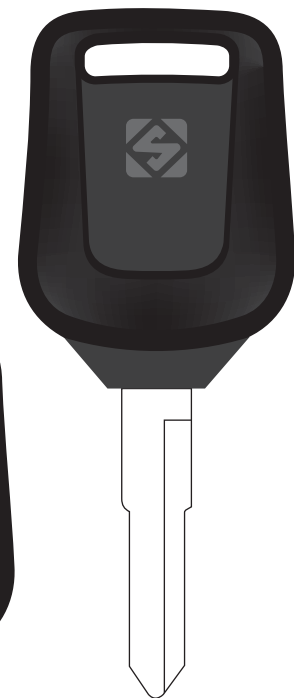

T7451
DOST - R

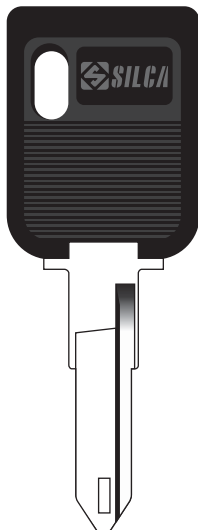

T8005
PEUGEOT

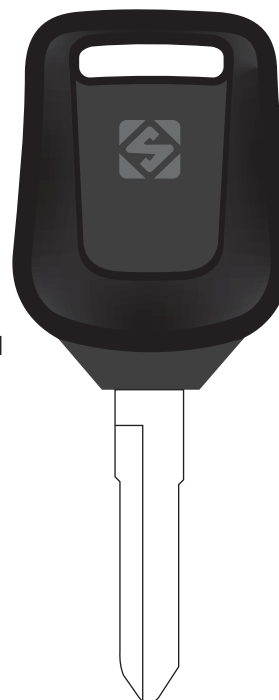

T7452
DOST - L

FOR CHEVROLET

FOR CHEVROLET / PEUGEOT /
VOLKSWAGEN / ASHOK LEYLAND

Four Wheelers Keys



FOR HONDA

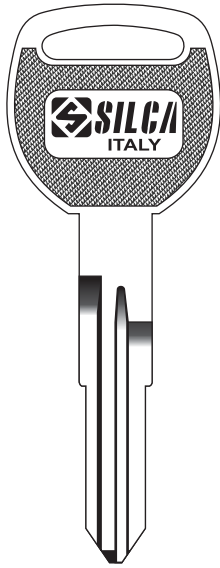

HON58R
CITY
(OLD)

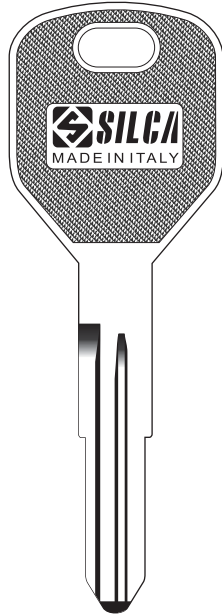

HON56R
ACCORD
(OLD)

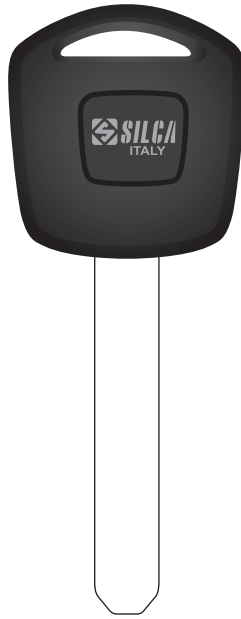

HON66GP
CITY
(NEW)

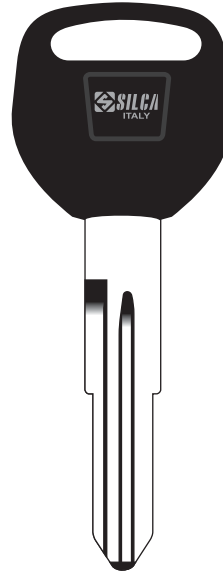

HON58RDP
CITY
(OLD)

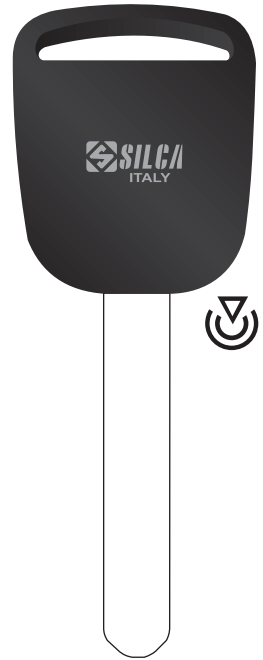

CHO03PT
CITY-ID46
(WITH TRANSPONDER)

FOR HYUNDAI

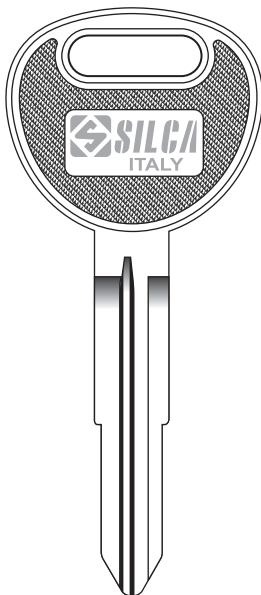

HYN10
SANTRO

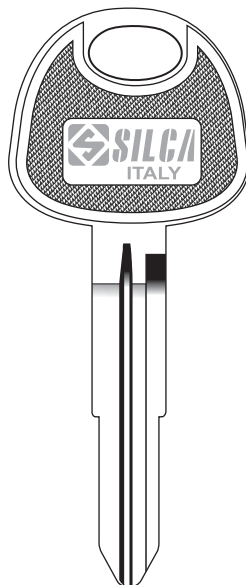

HYN11
ACCENT

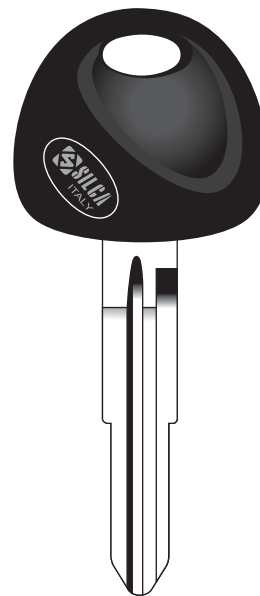

HYN11CP
ACCENT



T7089
SANTRO

Four Wheelers Keys

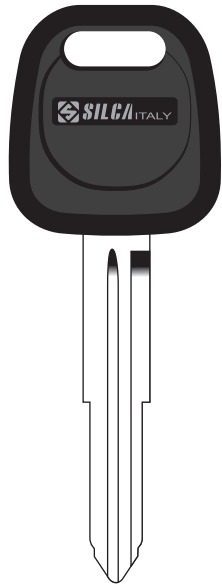

HYN4P
SONATA
(OLD)

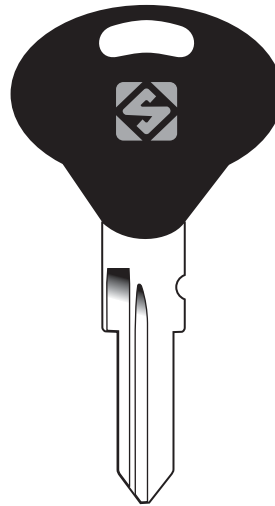

T7145
GIO

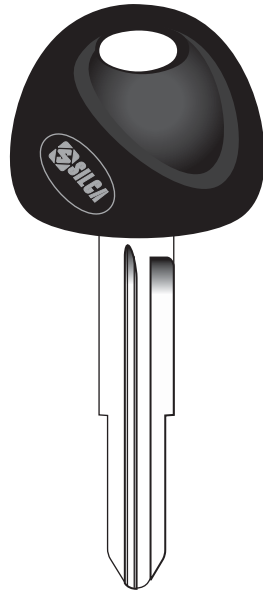

HYN12CP
VERNA

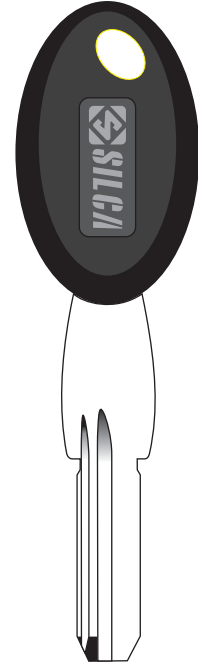

T7044
GEAR LOCK
(MINDA)

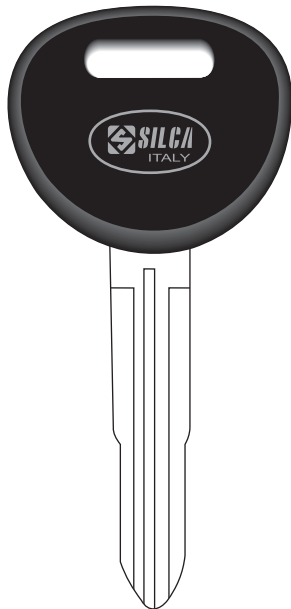

T 7089
SANTRO
(AFTERMARKET)

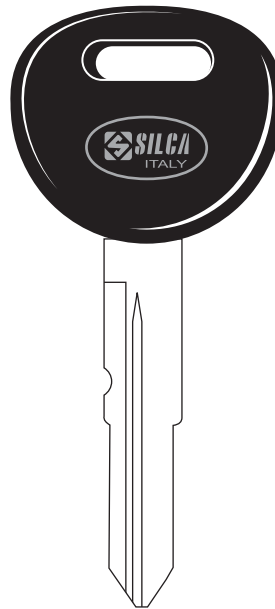

T7293
SANTRO
IGNITION LOCK

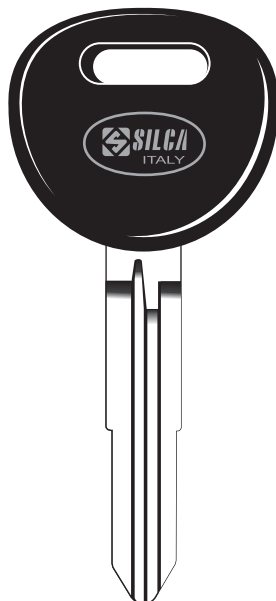

HYN10BP
SANTRO

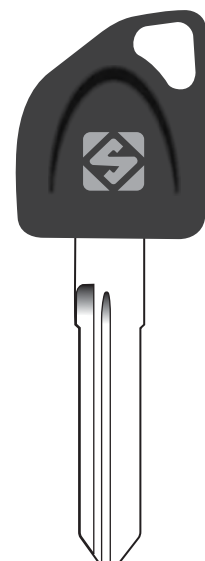

T7149
MAXXIMO

FOR HYUNDAI

FOR HYUNDAI / MAHINDRA

Four Wheelers Keys

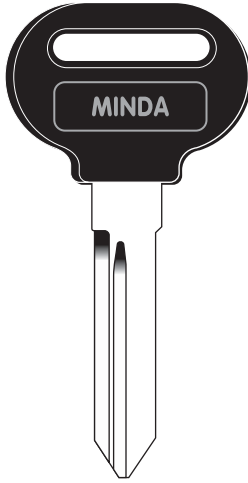

T7021
BOLERO

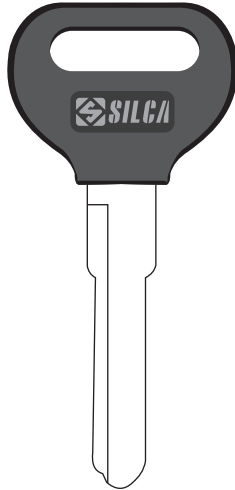

CMHN3RAP
BOLERO



T7059
JEEP

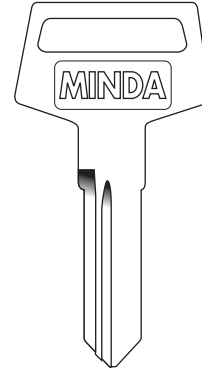

T7066
JEEP

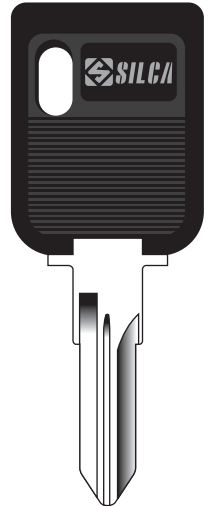

T8006
LOGAN

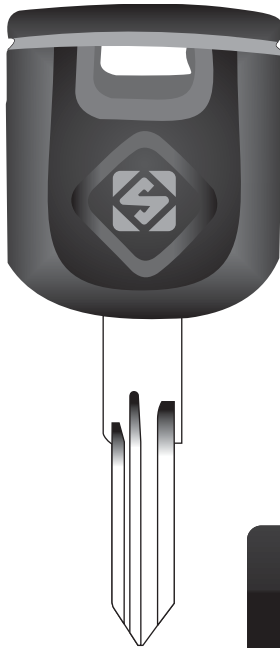

T7167
NAVISTAR



T8179
SCORPIO / XYLO



T7022
SCORPIO



A1175DZ-ID46
BOLERO ID46
(WITH TRANSPONDER)

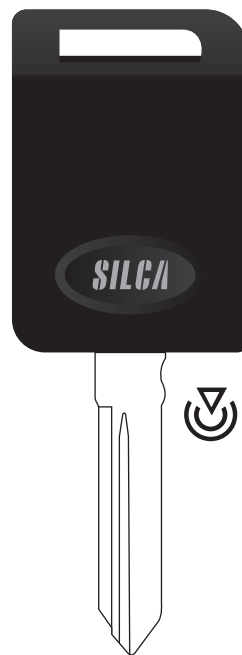

A1175DZ-ID47
BOLERO ID47
(WITH TRANSPONDER)

Four Wheelers Keys



FOR MARUTI SUZUKI



T7081
ZEN



SZ11RP
ZEN



SZ11P
ALTO



T7082
ALTO



SZ12P
BALENO (OLD)



SZ8P
800



SZ8RP
ESTEEM



T7020
CAR / VAN
(MINDA)



T7070
VAN



T7071
CAR



T7083
800
(MINDA)



T8153
SWIFT



SZ11
ALTO



SZ11R
ZEN



SZ12
BALENO

Four Wheelers Keys

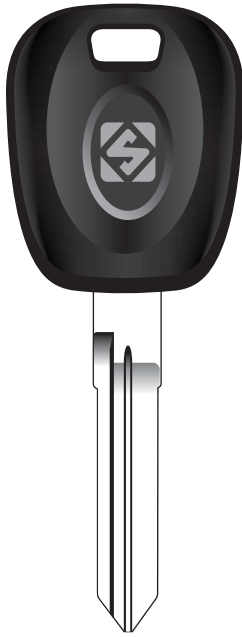

T8173
800

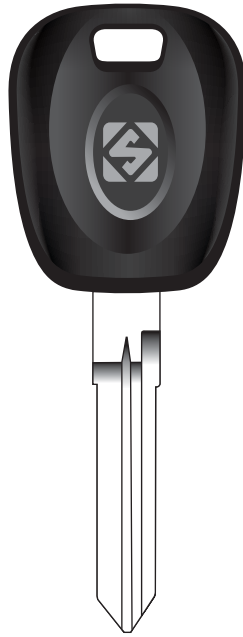

T8174
VAN



T8175
ALTO

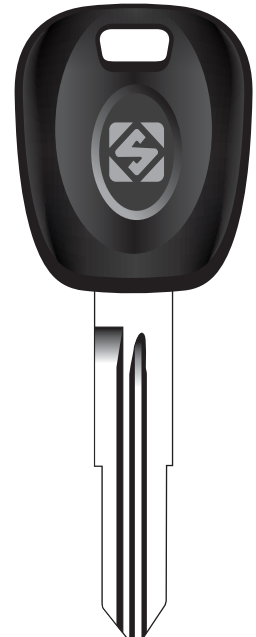

T8176
ZEN



T7084
VAN
(MINDA)

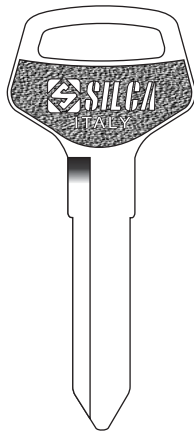

SZ8R
ESTEEM

Four Wheelers Keys



HU43P
VECTRA



T8047
ASTRA-L



T8039
ASTRA-R

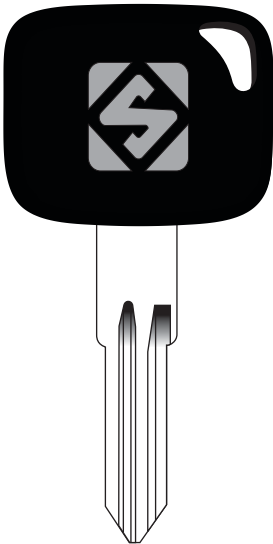

T7080
ASTRA

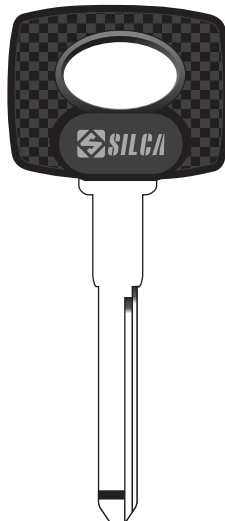

HU41P
S CLASS (NEW)

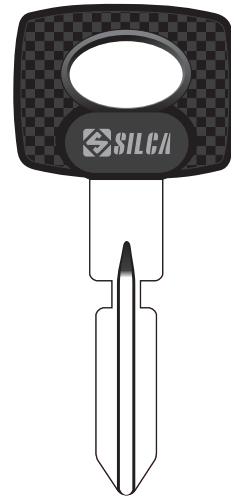

HU39P
S CLASS (OLD)

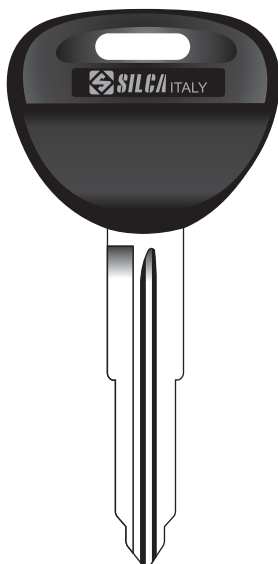

MIT11RAP
LANCER

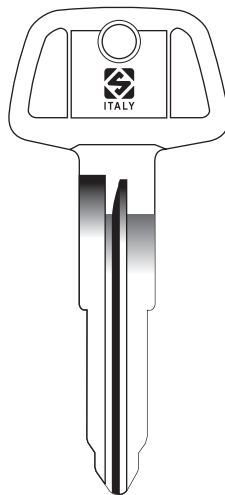

MIT11R
LANCER

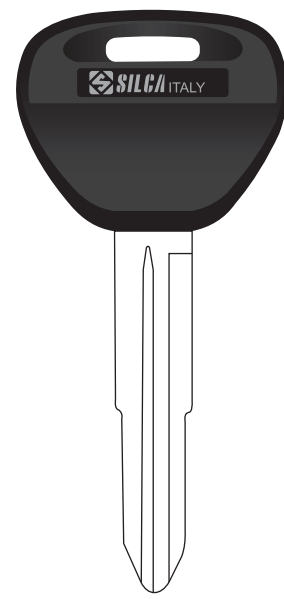

CMIT8AP10
PAJERO (STEEL)

FOR OPEL

FOR OPEL / MERCEDES BENZ

FOR MITSUBISHI

Four Wheelers Keys



FOR MITSUBISHI / SKODA

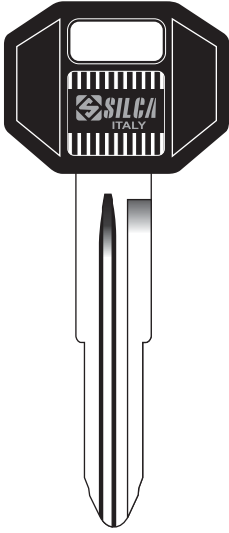

MIT8P
PAJERO

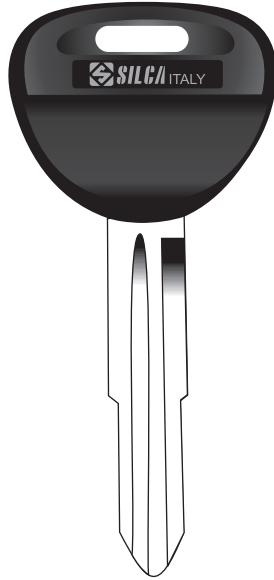

MIT8AP
PAJERO



HU66P
SKODA



HU66ATE
SKODA

FOR MUL-T-LOCK / TOYOTA

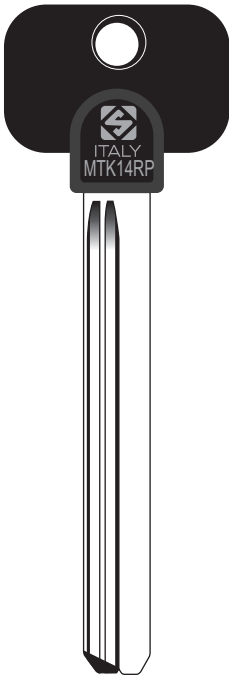

MTK14RP
MUL-T-LOCK



MTK4RP
MUL-T-LOCK

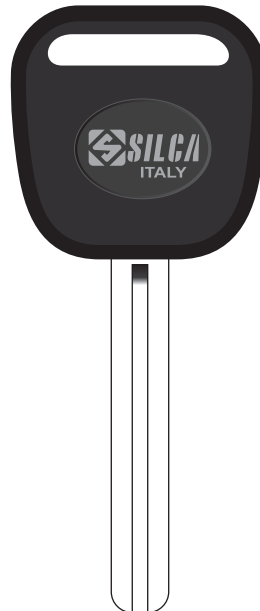

TOY40P
LEXUS

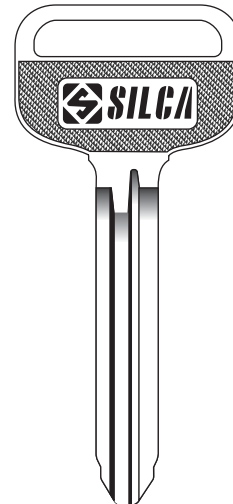

TOY43 10
QUALIS
(STEEL)

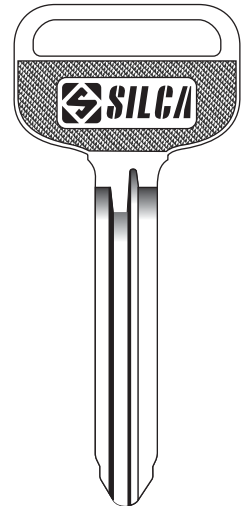

TOY43 20
QUALIS
(BRASS)

Four Wheelers Keys

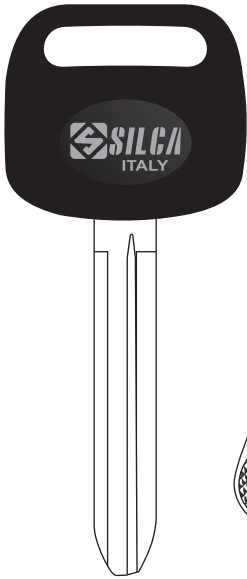

T8155
QUALIS
(STEEL)



T8156
QUALIS
(BRASS)



TOY4R
TOYOTA (OLD)



T7077
QUALIS
(BRASS)



T7166
MICRA

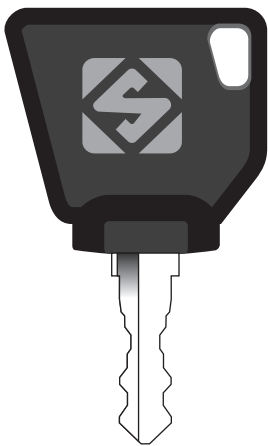

T7033
EARTH MOVER
JCB

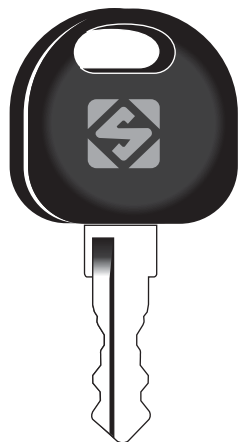

T7139
CRANE-ESCORTS

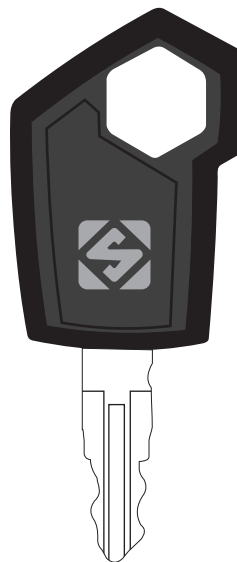

T7424
EARTH MOVER
CATERPILLAR

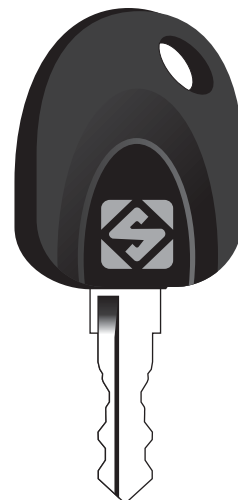

T7138
EARTH MOVER
TEREX VECTRA

FOR TOYOTA / NISSAN

FOR EXCAVATORS

Four Wheelers Keys



FOR TATA

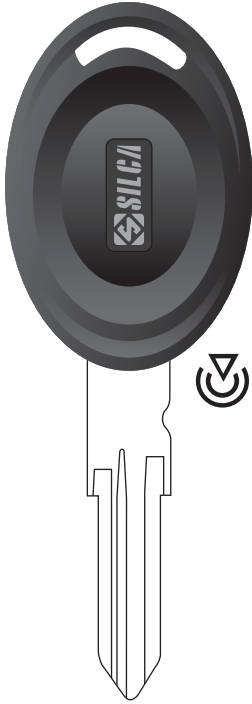

CTAT1T14
INDICA VISTA - ID46
(WITH TRANSPONDER)



T7168
SUMO VICTA

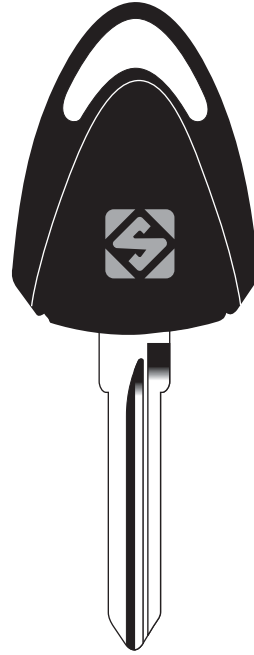

T8177
NANO



T7019
INDICA



T7045
SAFARI

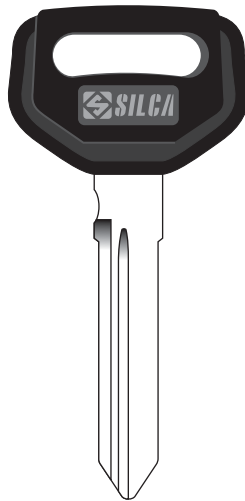

T7035
SUMO

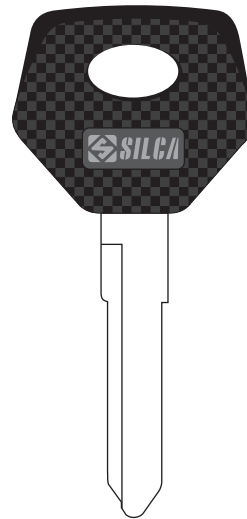

T7394
SUMO



T8072
SUMO

Four Wheelers Keys

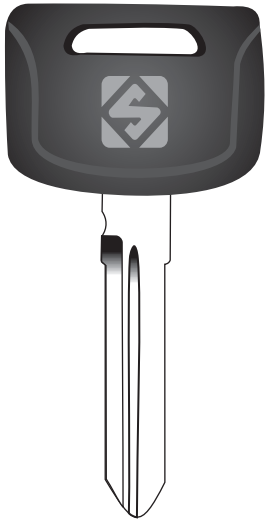

T7174
FORCE TEMPO

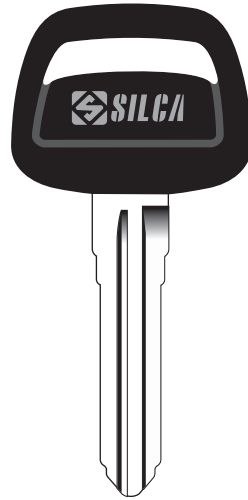

MAZ2RCP
MAZDA TRUCK

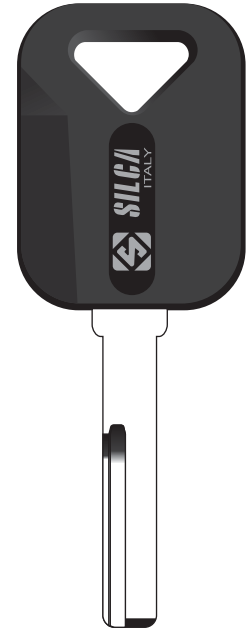

HU56RP
VOLVO TRUCK



HU72RP
BENZ TRUCK

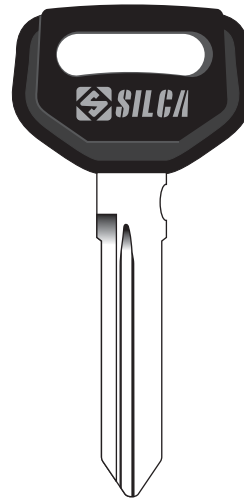

T7058
EICHER TRUCK



HU32P
MAN TRUCK

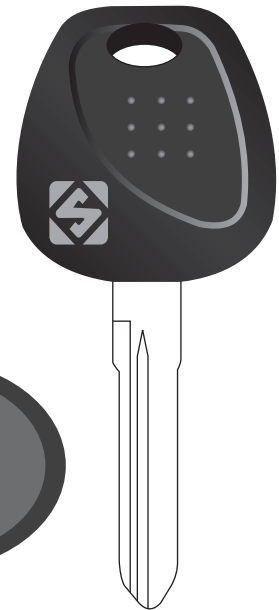

ML 55065
TATA TRUCK

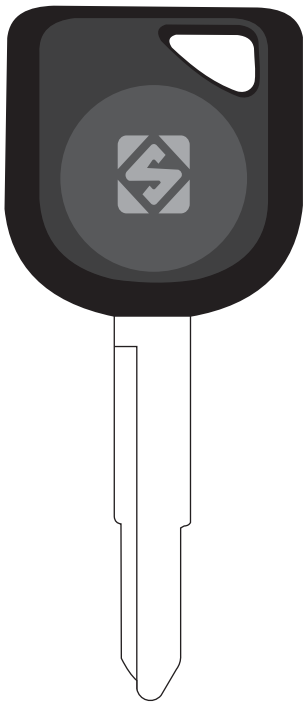

T 7427
BHARAT BENZ TRUCK

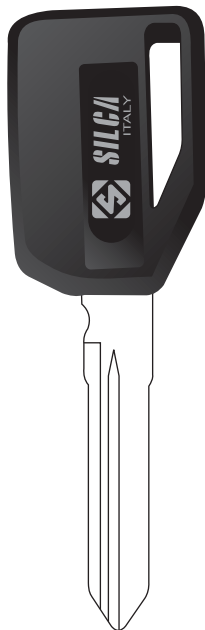

T7279
MAN TRUCK

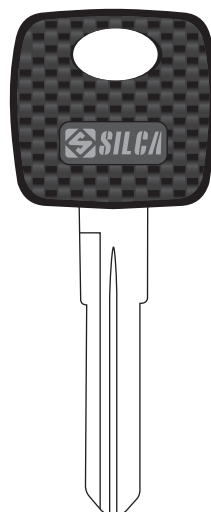

CTAT4RAP
TATA ACE

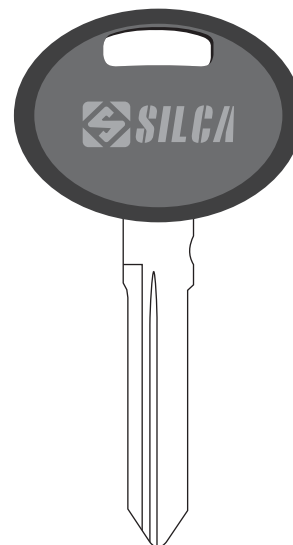

A1260
ASHOK LEYLAND TRUCK

FOR COMMERCIAL VEHICLES

Four Wheelers Keys

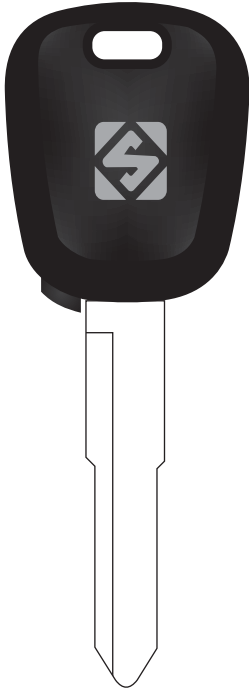

AHU133RTE
WAGON R

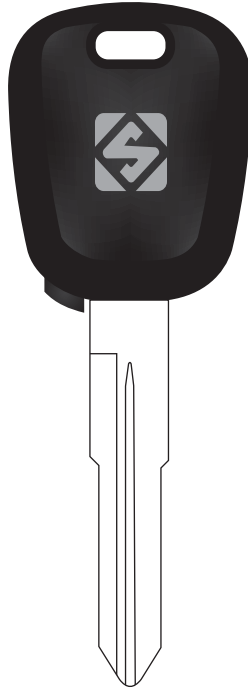

AT8153
SWIFT



T7434
VERNA

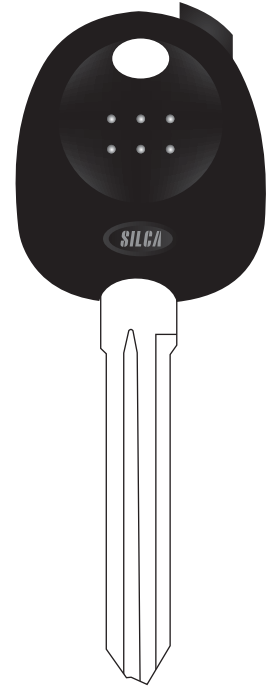

T7354
i10

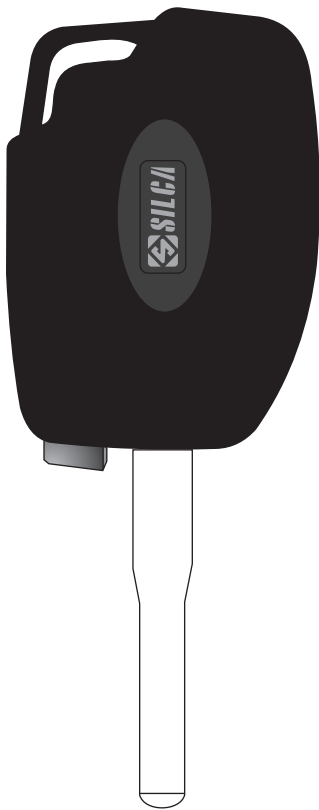

T7332
XYLO

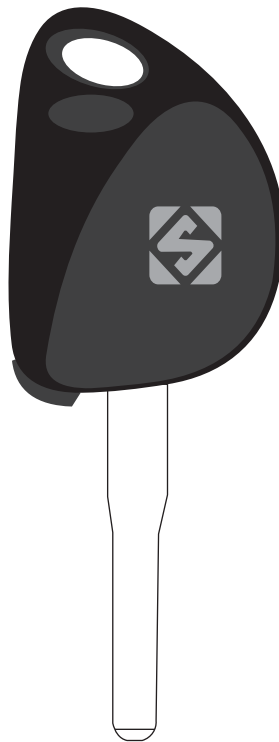

T7330
SCORPIO

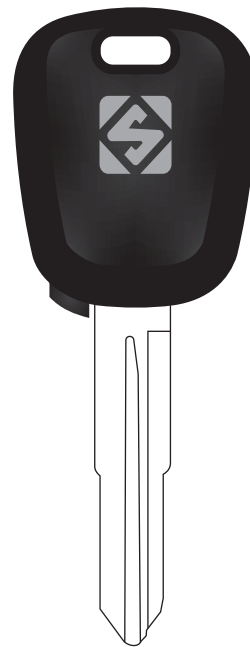

AT8175
ALTO



A1007Z
ETIOS

Four Wheelers Keys

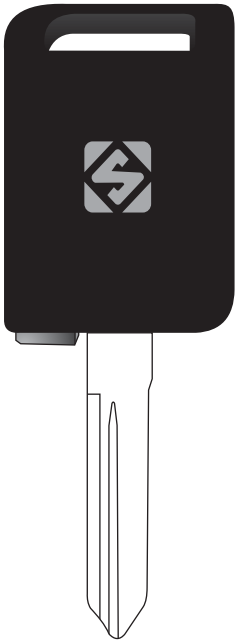

T7334
BOLERO

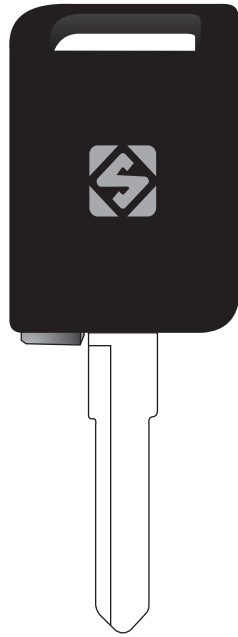

T7335
THAR

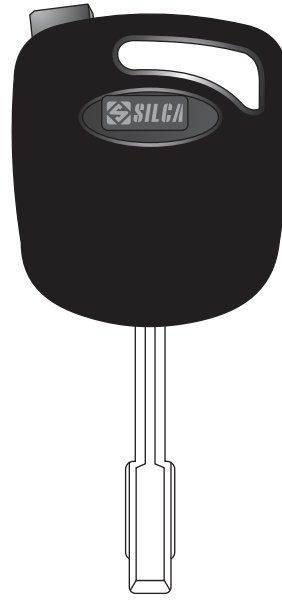

A4419Z
FIESTA

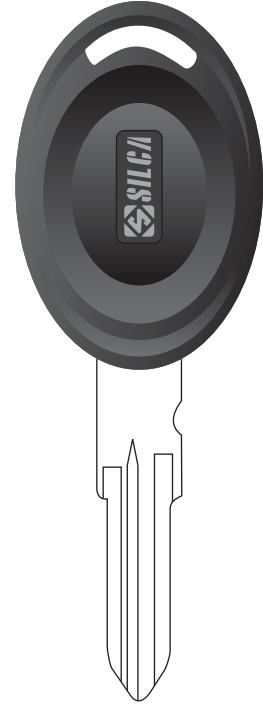

T7165
INDICA VISTA
(W/O TRANSPONDER)



T9014
SAFARI STORME



T9013
SANTRO



TR9087
XUV-500 REMOTE
UPPER COVER

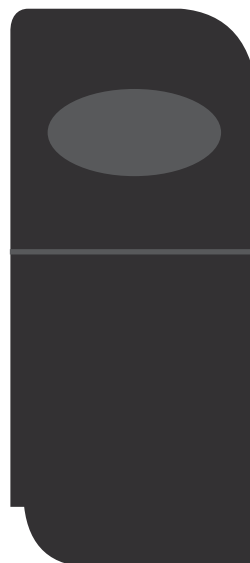

TR9089
XUV-500 REMOTE
LOWER COVER



T9009
INDIGO MANZA

KEY SHELLS

REMOTE COVERS

Four Wheelers Keys

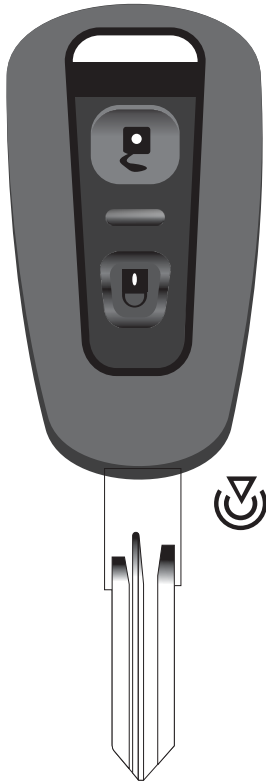

TR9086
INDIGO MANZA REMOTE
(With PCB &
TRANSPONDER ID46)

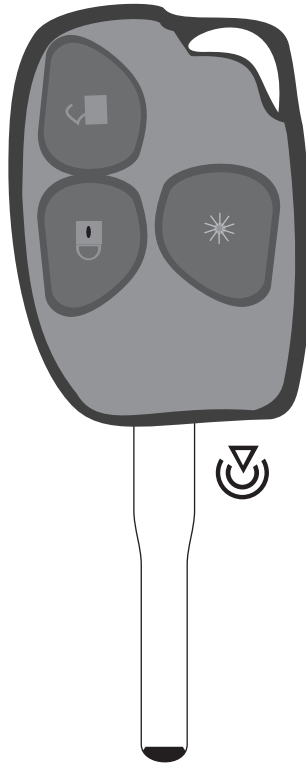

TR9085
XYLO REMOTE
(With PCB &
TRANSPONDER ID46)



TR9088
SAFARI REMOTE
(WITH PCB)



TR9083
BOLERO REMOTE
(WITH PCB &
TRANSPONDER ID47)



TR9084
BOLERO REMOTE
(WITH PCB &
TRANSPONDER ID46)



Please Scan this QR code for downloading Key Shell Range Catalogue



Key Shells Range

The line of Silca Empty Shells is the ideal solution where the original key cannot be used due to a broken or damaged mechanical part, whereas the electronic part can be used on the Silca key and can be recovered.

Silca Empty Shells, a currently available Silca product line of plastic headed vehicle keys and spare parts designed to integrate the original electronic component of remote controls.



Practical one-piece package for optimized stock management and hook display.



Model	For:	Year Range
HON66RS4	For: 2 7	
HONDA	→ ←	
ACCORD	2003	2006
ACCORD	2006	2008
CIVIC	2002	2005
CR-V	2002	2006
FR-V	2004	2007
FR-V	2007	2011
JAZZ	2001	2007
JAZZ	2006	2008
LEGEND	2007	2012
S2000	2004	2005
S2000	2006	2010
HU83BRS8N	For: 3 X 6	
CITROËN	→ ←	
C4 PICASSO	2006	2013
C5	2008	
C8	2006	
LANCIA	→ ←	
PHEDRA	2006	2010
PEUGEOT	→ ←	
308	2007	2013
807	2006	2014
3008	2009	
5008	2009	
HU66RS1	For: 1	
PORSCHE	→ ←	
911	1999	2004
BOXSTER	1999	2004
HU66RS2	For: 2	
PORSCHE	→ ←	
911	1999	2004
BOXSTER	1999	2004

Empty Shells

HON66RS3



For: 2 ⊗

HONDA	→	→
ACCORD	2003	2006
CIVIC	2006	2012
CR-V	2007	2012
JAZZ	2009	
STREAM	2008	

HON66RS5



For: 3 ⊗

HONDA	→	→
ACCORD	2003	2006
CIVIC	2006	2012
CR-V	2007	2012
JAZZ	2009	
STREAM	2008	

HON66RS6



For: 3 ⊗ Ⓟ

HONDA	→	→
ACCORD	2003	2006
ACCORD	2006	2008

HU83ARS2N



For: 2 ⊗ Ⓟ

CITROËN	→	→
C6	2005	2012
JUMPY	2007	
PEUGEOT	→	→
207	2006	
307	2001	2009
3008	2009	
EXPERT	2007	

HYN12RS1



For: 1

HYUNDAI	→	→
H-1	1998	2006
H-200	1998	2006
STAREX	1998	2006

HU83CRS7



For: 4 Ⓟ

CITROËN	→	→
C8	2006	
LANCIA	→	→
PHEDRA	2006	2010
PEUGEOT	→	→
807	2006	2014

HU83CRS7N



For: 4 ⊗ Ⓟ

CITROËN	→	→
C8	2006	
LANCIA	→	→
PHEDRA	2006	2010
PEUGEOT	→	→
807	2006	2014

HURS5



For: 3 ⊗

MERCEDES	→	→
B-CLASS	2005	2010
C-CLASS	2001	2007
CLK	2001	2009
E-CLASS	1998	2009
ML-CLASS	2005	2010
S-CLASS	1999	2006
SLK	2005	2010

HU83RS2



For: 2

CITROËN	→	→
C4 PICASSO	2006	2013
DISPATCH	2007	
JUMPY	2007	

SIP22RS8



For: 3 Ⓟ

FIAT	→	→
BRAVO	2007	2008
DUCATO	2002	2005
IDEA	2003	2009
PUNTO	2006	2011
STILO	2001	2008
LANCIA	→	→
LYBRA	2002	2006
MUSA	2004	2009
THESIS	2002	2009
YPSILON	2003	2011

HU66RS8



For: 3

PORSCHE	→	→
911	1999	2004
BOXSTER	1999	2004

HURSA8



For: 3

SEAT	→	→
ALTEA	2004	2008
ALTEA XL	2006	2008
LEON	2005	2008
TOLEDO	2005	2008
SKODA	→	→
OCTAVIA	2004	2006
ROOMSTER	2006	2008
ROOMSTER SCOUT	2007	2008
VOLKSWAGEN	→	→
CROSS GOLF	2006	2007
EOS	2006	2007
GOLF	2004	2008
INDIVIDUAL	2004	2008
JETTA	2004	2007
PASSAT	2004	2005
TOURAN	2003	2007

HU87RS2



For: 2

OPEL-VAUXHALL	→	→
AGILA	2000	2004
SUBARU	→	→
G3X JUSTY	2004	2007
SUZUKI	→	→
IGNIS	2000	2005
WAGON R	2000	2008

MIT8RS2



For: 2

MITSUBISHI	→	→
L200	2006	
PAJERO	2006	

HYN12RS1



For: 1

HYUNDAI	→	→
H-1	1998	2006
H-200	1998	2006
STAREX	1998	2006

MIT11RS2



For: 2

MITSUBISHI	→	→
380	2006	
ECLIPSE	2008	2012
ENDEAVOR	2007	2011
GALANT	2006	2012
GRANDIS	2003	2011
I-MIEV	2010	
LANCER	2006	
OUTLANDER	2006	

MIT11RS5



For: 3 Ⓟ

MITSUBISHI	→	→
SOME MODELS	2006	

NE73RS2



For: 2

PEUGEOT	→	→
106	2000	2004
206	2001	2009
206 Cabrio	2002	2007
206 PLUS	2009	2012

TOY41RRS2



For: 2

TOYOTA	→	→
ECHO	1999	2005
MR2	1997	2007
YARIS	1999	2005
TOYOTA JAPAN	→	→
PLATZ	1999	2002
TOYOTA USA	→	→
MR2	2001	2005

TOY43ARS9



For: 3 Ⓟ

TOYOTA USA	→	→
AVALON	2005	2011
CAMRY	2003	2011
COROLLA	2005	2010

Empty Shells

TOY43ARS7



For: **4**

TOYOTA	→	→
PREVIA	2006	
TARAGO	2006	
TOYOTA USA	→	→
SIENNA	2006	2010

TOY40BRS2



For: **2**

LEXUS	→	→
CELSIOR [J]	1997	2000
ES300	1998	2001
LAND CRUISER [J]	1999	
LS400	1997	2000
LX450	1998	2002
LX470	1999	2000
SC300/400	1998	2003

NE73RS2



For: **2**

PEUGEOT	→	→
106	2000	2004
206	2001	2009
206 Cabrio	2002	2007
206 PLUS	2009	2012

TOY43ARS7



For: **4**

TOYOTA	→	→
PREVIA	2006	
TARAGO	2006	
TOYOTA USA	→	→
SIENNA	2006	2010

SIP22RS8



For: **3**

FIAT	→	→
BRAVO	2007	2008
DUCATO	2002	2005
IDEA	2003	2009
PUNTO	2006	2011
STILO	2001	2008
LANCIA	→	→
LYBRA	2002	2006
MUSA	2004	2009
THESIS	2002	2009
YPSILON	2003	2011

TOYOTA → →

CENTURY	1998	
LAND CRUISER 100	1998	2000
TOYOTA JAPAN	→	→
CELSIOR	1998	2004

TOY43ARS2



For: **2**

TOYOTA	→	→
AURIS	2006	2012
COROLLA	2007	2013
HILUX	2005	2012
INNOVA KIJANG	2005	
LAND CRUISER 200	2012	
LAND CRUISER PRADO	2013	
PREVIA	2006	
RAV 4	2005	2012
TARAGO	2006	
WISH	2004	2009
YARIS	2005	2011
TOYOTA USA	→	→
HIACE	2006	2013
HILUX	2004	2012
HILUX	2012	

TOY43ARS8



For: **3**

TOYOTA USA	→	→
AVALON	2005	2011
CAMRY	2003	2011
COROLLA	2005	2010

TOY41RBRS8



For: **3**

TOYOTA	→	→
ECHO	1999	2005
MR2	1997	2007
YARIS	1999	2005
TOYOTA JAPAN	→	→
PLATZ	1999	2002
TOYOTA USA	→	→
MR2	2001	2005

MIT8RS2



For: **2**

MITSUBISHI	→	→
L200	2006	
PAJERO	2006	

TOY41RRS2



For: **2**

TOYOTA	→	→
ECHO	1999	2005
MR2	1997	2007
YARIS	1999	2005
TOYOTA JAPAN	→	→
PLATZ	1999	2002
TOYOTA USA	→	→
MR2	2001	2005

TOY43CRS7N



For: **4**

SUBARU	→	→
BRZ	2012	
TOYOTA	→	→
COROLLA	2011	
GT 86	2012	
VERSO-S	2011	
YARIS	2011	

TOY40BRS8



For: **3**

LEXUS	→	→
CELSIOR [J]	1997	2000
ES300	1998	2001
LAND CRUISER [J]	1999	
LS400	1997	2000
LX450	1998	2002
LX470	1999	2000
SC300/400	1998	2003
TOYOTA	→	→
CENTURY	1998	
LAND CRUISER 100	1998	2000
TARAGO	1995	1998
TOYOTA JAPAN	→	→
CELSIOR	1998	2004

MIT11RRS2



For: **2**

MITSUBISHI	→	→
380	2006	
ECLIPSE	2008	2012
ENDEAVOR	2007	2011
GALANT	2006	2012
GRANDIS	2003	2011
I-MiEV	2010	
LANCER	2006	
OUTLANDER	2006	

TOY43ARS9



For: **3**

TOYOTA USA	→	→
AVALON	2005	2011
CAMRY	2003	2011
COROLLA	2005	2010

TOY41RBRS8



For: **3**

TOYOTA	→	→
ECHO	1999	2005
MR2	1997	2007
YARIS	1999	2005
TOYOTA JAPAN	→	→
PLATZ	1999	2002
TOYOTA USA	→	→
MR2	2001	2005

MIT11RRS5



For: **3**

MITSUBISHI	→	→
SOME MODELS	2006	

TOY43ARS10



For: **4**

TOYOTA USA	→	→
AVALON	2005	2011
CAMRY	2003	2011
COROLLA	2005	2010
RAV 4	2006	2010
VENZA	2009	2010
YARIS	2007	2011

TOY40BRS8



For: **3**

LEXUS	→	→
CELSIOR [J]	1997	2000
ES300	1998	2001
LAND CRUISER [J]	1999	
LS400	1997	2000
LX450	1998	2002
LX470	1999	2000
SC300/400	1998	2003

TOYOTA	→	→
CENTURY	1998	
LAND CRUISER 100	1998	2000
TARAGO	1995	1998

TOYOTA JAPAN	→	→
CELSIOR	1998	2004

TOY48BRS8



For: **3**

LEXUS	→	→
ALTEZZA [J]	1999	2005
ES300	2002	2003
GS/LS/LX	1998	2005
IS200	1999	2005
IS300	2001	2005
RX300	1999	2003

TOYOTA	→	→
LAND CRUISER 100	1996	2003

TOYOTA JAPAN	→	→
CELSIOR	1998	2004

TOY47BRS8



For: **3**

TOYOTA	→	→
AVENSIS	1998	2000
AVENSIS	2000	2003
AVENSIS	2003	2006
CARINA	1996	2000
COROLLA	1999	2006
YARIS	1999	2005

TOY43BRS2



For: **2**

TOYOTA	→	→
CELICA	2000	2005
COROLLA	1996	1999
HIACE	1995	2006
HILUX	1999	2004
LAND CRUISER PRADO	2002	2010
PICNIC	1996	2003
PREVIA	2000	2005
PRIUS	2000	2003
RAV 4	1996	2004
TARAGO	2000	2005

TOYOTA JAPAN	→	→
GAIA	1999	2004
IPSUM	1996	2003

TOYOTA USA	→	→
4RUNNER	1998	2002
4RUNNER	2003	2010
AVALON	1998	2004
CAMRY	1998	2004
HIGHLANDER	2001	2003
HIGHLANDER	2004	2008
LAND CRUISER	1998	2002
LAND CRUISER	2003	2008
RAV 4	2004	2006
SEQUOIA	2001	2002
SEQUOIA	2003	2010
SIENNA	1999	2003
SIENNA	2004	2008
SOLARA	2002	2003
SOLARA	2004	2010

TOY40BRS2



For: **2**

LEXUS	→	→
CELSIOR [J]	1997	2000
ES300	1998	2001
LAND CRUISER [J]	1999	
LS400	1997	2000
LX450	1998	2002
LX470	1999	2000
SC300/400	1998	2003

TOYOTA	→	→
CENTURY	1998	
LAND CRUISER 100	1998	2000

TOYOTA JAPAN	→	→
CELSIOR	1998	2004

TOY43BRS8



For: **3**

TOYOTA	→	→
AVENSIS VERSO	2004	2009
CELICA	2000	2005
COROLLA	1996	1999
COROLLA	2000	2006
HIACE	1995	2006
LAND CRUISER PRADO	2002	2010
PICNIC	1996	2003
PRIUS	2000	2003
RAV 4	1996	2004

TOYOTA JAPAN	→	→
GAIA	1999	2004
IPSUM	1996	2003
KLUGER	2003	2007

TOYOTA USA	→	→
4RUNNER	1998	2002
4RUNNER	2003	2010
AVALON	1998	2004
CAMRY	1998	2004
HIGHLANDER	2001	2003
HIGHLANDER	2004	2008
LAND CRUISER	1998	2002
LAND CRUISER	2003	2008
RAV 4	2004	2006
SEQUOIA	2001	2002
SEQUOIA	2003	2010
SIENNA	1999	2003
SIENNA	2004	2008
SOLARA	2002	2003
SOLARA	2004	2010

TOY48BRS8



For: **3**

TOYOTA JAPAN	→	→
CROWN	2005	2011
REIZ	2005	2011

VA2RS2



For: **2**

CITROËN	→	→
BERLINGO	2002	2008
C1	2004	
C2	2003	2010
C3	2002	

PEUGEOT	→	→
107	2005	2014
PARTNER	2002	
RANCH	2002	2007

TOYOTA	→	→
AYGO	2005	2014

VACRSA2



For: **2**

RENAULT-DACIA	→	→
LOGAN	2006	2012
SANDERO	2008	2013

TOY47BRS2



For: **2**

TOYOTA	→	→
AVENSIS	1998	2000
AVENSIS	2000	2003
AVENSIS	2003	2006
CARINA	1996	2000
COROLLA	1999	2006
YARIS	1999	2005

VACRSA2



For: **2**

OPEL-VAUXHALL	→	→
MOVANO	2002	2010

RENAULT	→	→
KANGOO	2002	2010
MASTER	2002	2010
TWINGO	2002	2007

Look A-like keys range

GTI is compatible with the new Silca Look A-like transponder keys series: a vehicle keys range with key head design identical to the original.

You will be able to easily recognize Silca Look A-like keys range thanks to the reference ending in TE (eg. FO10TE).

- Key head design identical to the original.
- Wide and continuously updated keys range.

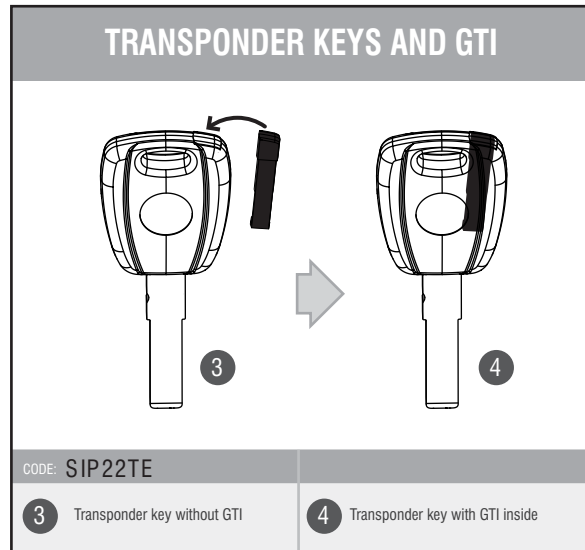
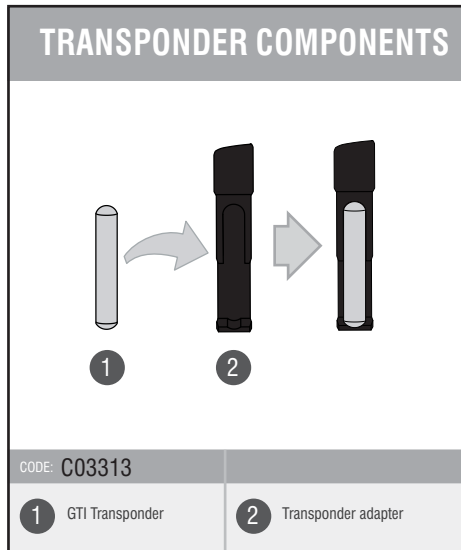

CY24TE

CHRYSLER	For:	→	→
200	2011		
300	1998	2004	
300	2005	2008	
ASPEN	2007	2009	
CIRRUS	1999	2000	
CIRRUS Convertible	2001	2002	
CIRRUS SEDAN	2001	2002	
CONCORDE	1998	2004	
LHS	1999	2001	
NEON	2000	2005	
NEW YORKER	1998	2001	
PACIFICA	2004	2008	
PT CRUISER	2001	2005	
PT CRUISER	2006	2011	
PT CRUISER LE	2001	2005	
SEBRING	2007	2011	
SEBRING CONVERT	2001	2006	
SEBRING CONVERT	2007	2010	
SEBRING SEDAN	1999	2006	
STRATUS	1998	2006	
TOWN & COUNTRY	2001	2004	
TOWN & COUNTRY	2004	2007	
VISION	1998		
VOYAGER	1998	2003	
VOYAGER	2004	2007	
DODGE	→	→	→
AVENGER	2008		
CALIBER	2007	2012	
CARAVAN	2001	2003	
CARAVAN	2004	2007	
CHARGER	2005	2008	
DAKOTA	2001	2004	
DAKOTA	2005	2011	
DURANGO	2001	2004	
DURANGO	2005	2009	
INTREPID	1998	2004	
INTREPID SEDAN, ES	2001	2004	
MAGNUM	2005	2008	

NEON	2000	2005
NITRO	2007	2012
RAM	2002	2005
RAM	2006	2011
STRATUS SEDAN	1998	2006
EAGLE	→	→
VISION	1998	
JEEP	→	→
CHEROKEE	1998	2004
CHEROKEE	2005	
CHEROKEE LIMITED	1995	2005
CJ5, CJ7	1998	2005
CJ5, CJ7	2006	
COMANCHE	2006	
COMMANDER	2000	2008
COMPASS	2007	
G. CHEROKEE	2005	2008
G. CHEROKEE LUX	1999	2005
G. CHEROKEE SPORT	1998	2004
LIBERTY	2002	2004
LIBERTY	2005	
PATRIOT	2007	
WRANGLER	1998	2006
WRANGLER	2006	
MITSUBISHI	→	→
RAIDER	2006	2010
PLYMOUTH	→	→
BREEZE	1999	2001
NEON	2000	2001
PROWLER	2000	2002
STERLING	→	→
BULLET	2008	

DW04RTE

CHEVROLET-DAEWOO	→	→
AVEO	2006	2011
KALOS	2002	2006
LACETTI	2002	2004
LACETTI	2004	2009
NUBIRA	2000	2002
NUBIRA SW	2004	2009
TACUMA	2000	2008
CHEVROLET USA	→	→
CAPTIVA	2006	
EPICA	2006	
EPICA	2008	
EVANDA	2003	2006
LEGANZA	2000	2008
CHEVROLET USA	→	→
CAPTIVA SPORT	2012	
OPEL-VAUXHALL	→	→
ANTARA	2007	
SATURN (GM)	→	→
VUE	2008	2010

FO21TE

FORD AUS	→	→
FALCON	1999	2006
TERRITORY	2004	2005
FORD EU	→	→
COUGAR	1997	2002
COURIER KOMBI	1998	2002
ESCORT	1995	2000
FIESTA	1995	2002
FIESTA	2003	2008
FOCUS	1998	2004
FUSION	2002	
KA	1996	2002
KA	2002	2008
MONDEO	1995	2001
MONDEO	2001	2007
PUMA	1998	2002
SCORPIO	1995	1998
TOURNEO CONNECT	2002	2008
TOURNEO CONNECT	2009	2013
TRANSIT	1995	2000
TRANSIT	2000	2006
TRANSIT	2007	2013
TRANSIT CONNECT	2002	2008
TRANSIT CONNECT	2009	2013
FORD SUD-AMERICA	→	→
FOCUS	1998	2007
KA	2008	
MONDEO	2006	2007
FORD USA	→	→
TRANSIT CONNECT	2010	2012
JAGUAR	→	→
S-TYPE	2000	2008
XJ	2003	2007
X-TYPE	2002	2008
MAZDA	→	→
121	1997	2001

Look A Like Keys



HU100TE

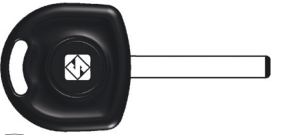

For:

BUICK	→	→
ALLURE	2010	2012
ENCORE	2014	
LACROSSE	2010	
REGAL	2011	
VERANO	2012	
CADILLAC	→	→
SRX	2010	
CHEVROLET-DAEWOO	→	→
AVEO	2011	
CRUZE	2009	
MALIBU	2013	
ORLANDO	2011	
TRAX	2013	
VOLT	2012	
CHEVROLET SUD-AMERICA	→	→
AGILE	2009	
ONIX	2012	
PRISMA	2012	
TRACKER	2013	
CHEVROLET USA	→	→
CAMARO	2010	
CRUZE	2011	
EQUINOX	2010	
IMPALA	2014	
MALIBU	2013	
ORLANDO	2012	2013
SILVERADO	2014	
SONIC	2012	
VOLT	2011	
GMC (GM)	→	→
SIERRA	2014	
TERRAIN	2010	
HOLDEN	→	→
ASTRA	2004	
VECTRA	2004	
ZAFIRA	2004	

OPEL-VAUXHALL

ADAM	2013	
AMPERA	2012	
ASTRA	2004	
CABRIO	2013	
CASCADA	2013	
CORSA	2006	
INSIGNA	2008	
MERIVA	2010	
MOKKA	2012	
SIGNUM	2003	2008
VECTRA	2004	2008
ZAFIRA	2006	
SATURN (GM)	→	→
ASTRA	2008	2009

HU101TE

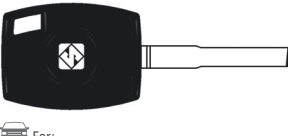

For:

FORD AUS	→	→
BF FALCON	2005	
TERRITORY	2005	
FORD EU	→	→
FIESTA	2008	2012
FOCUS	2004	2010
FOCUS C-MAX	2003	2010
GALAXY	2006	2010
KUGA	2008	2012
MONDEO	2007	2010
S-MAX	2006	2010
FORD SUD-AMERICA	→	→
MONDEO	2007	
LAND ROVER	→	→
DISCOVERY 3	2006	2009
RANGE ROVER SPORT	2006	2009

HU133RTE



For:

FIAT	→	→
SEDICI	2006	
MARUTI SUZUKI	→	→
ALTO K10	2010	
A-STAR	2007	
RITZ	2007	
SWIFT	2007	
SX4	2007	
WAGON R	2010	
NISSAN	→	→
PIXO	2009	
OPEL-VAUXHALL	→	→
AGILA	2008	
SUZUKI	→	→
ALTO	2009	
GRAND VITARA	2008	
IGNIS	2003	2008
JIMNY	2002	
SPLASH	2008	
SWIFT	2005	
SX4	2006	

HYN6TE

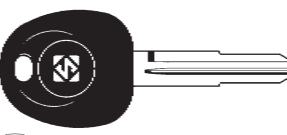

For:

HYUNDAI	→	→
ACCENT	1999	2011
COUPE	1996	2001
COUPE	2001	2009
ELANTRA	2000	2006
EXCEL	1999	
GALLOPER	1999	2003
GETZ	2002	2009
H-1	1999	2006
H-1	2006	
INNOVATION	1999	2003
LANTRA	1996	2000
LAVITA	2001	2010
MATRIX	2002	2010
SANTAFE	2002	2006
SANTAMO	2000	2003
SCOPE	1999	1996
TERRACAN	2001	2007
TIBURON	2001	2008
TUCSON	2005	2009
VERNA	1999	
KIA	→	→
MORNING	2006	
PICANTO	2004	2008
SPORTAGE	2006	

HYN7RTE

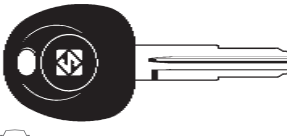

For:

HYUNDAI	→	→
GRANDEUR XG (AUS)	1998	2005
SANTAFE	2000	2002
SONATA	1996	1998
SONATA	1998	2004
SONICA	1996	1998
SONICA	1999	2004
TRAJET	2000	2006
XG25/XG30	1998	2005
Xg300 (CANADA)	1998	2005
KIA	→	→
SORENTO	2002	2009

HYN10TE

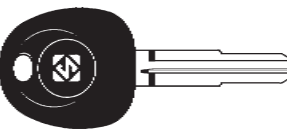

For:

HYUNDAI	→	→
ACCENT	1996	1999
ATOS	1997	2000
ATOS PRIME	1999	2001
ATOS PRIME	2002	2008
EXCEL	1996	1999
PONY	1995	1999
VERNA	1996	1999

HYN12TE



For/Per/Für/Pour/Para:

HYUNDAI	→	→
STAREX	1998	2006

HYN14TE



For:

HYUNDAI	→	→
ENTOURAGE	2007	2009
I10	2008	
H-1 BUS	2007	
KIA	→	→
CARENS	2006	
CARNIVAL	2006	
OPTIMA	2006	
SEDONA	2006	

HYN14RTE



For:

HYUNDAI	→	→
ELANTRA	2007	
GENESIS C.PE	2010	
iLOAD	2008	
iMAX	2008	
SANTA FE	2006	
SONATA	2005	
VERACRUZ	2007	2012
KIA	→	→
FORTE (CDN)	2008	2011
MAGENTIS	2006	2008
RONDO	2007	2010
SOUL	2009	

HYN15TE

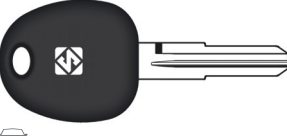

For:

KIA	→	→
RIO	2006	2009

HYN17BTE

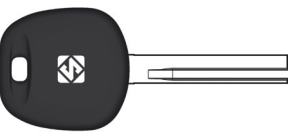

For:

HYUNDAI	→	→
ACCENT (AUS)	2012	
VELOSTER (AUS)	2012	

HYN17RBTE

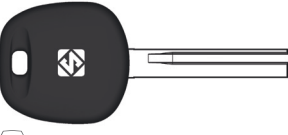

For:

HYUNDAI	→	→
SANTA FE (AUS)	2013	

KW16TE

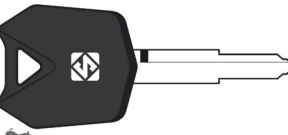

For:

KAWASAKI	→	→
NINJA ZX-6R	2006	
NINJA ZX-10R	2004	2010
NINJA ZX-12R	2002	2006
NINJA ZX-14R	2006	2011
Z1000	2004	2009
Z750S	2006	
ZZR1200	2002	2006
ZZR1400	2007	2011

MAZ24RTE

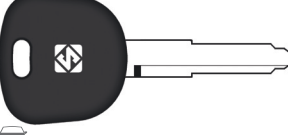

For:

MAZDA	→	→
CX-7	2007	
CX-9	2007	
DEMIO [J]	2003	2014
MAZDA 2	2003	2014
MAZDA 3	2003	2014
MAZDA 5	2015	
MAZDA 6	2003	2012
MX-5	2005	
RX-8	2004	2012

NE73TE



For:

NISSAN	→	→
INTERSTAR	2002	2010
OPEL-VAUXHALL	→	→
MOVANO	2002	2010
PEUGEOT	→	→
106	2000	2004
206	2001	2009
206 Cabrio	2002	2007
206 PLUS	2009	2012
RENAULT	→	→
AVANTIME	2001	2003
MASTER	2002	2010
MEGANE	1998	2000
MEGANE	2000	2003

Look A Like Keys



SZ18TE



For: **MARUTI SUZUKI** → →
800 2007 2010

SZ18RTE



For: **MARUTI SUZUKI** → →
ESTEEM 2007 2010
OMNI 2007 2010

SZ22TE

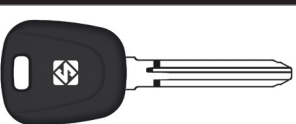

For: **SUZUKI** → →
GRAND VITARA 2006 2008
LIANA 2001 2005
LIANA 2006 2007
SWIFT 2005

TAT1TE



For: **TATA** → →
ARIA 2010
INDICA 2008
INDIGO 2008
MANZA 2009

TOY43ATE



For: **PONTIAC** → →
VIBE 2009 2010
SCION → →
TC 2005 2010
XA 2004 2007
XB 2004 2008
XD 2008 2012
TOYOTA → →
4RUNNER 1999 2002
ALPHARD 2005
AURION (AUS) 2006
AURIS 2006
AVENSIS VERSO 2001 2003
CAMRY 1996 2005

CAMRY	2006	
CELICA	2000	2005
COROLLA	2007	2013
ECHO VERSO	2002	2005
FJ CRUISER	2007	
FORTUNER	2007	
HIACE	1995	2006
HIACE	2007	
HILUX	1999	2004
HILUX	2005	2012
INNOVA KIJANG	2005	
IQ	2008	
LAND CRUISER 90	1996	2002
LAND CRUISER 100	1998	2002
LAND CRUISER 100	2003	2008
LAND CRUISER 120	2002	
LAND CRUISER PRADO	2002	2010
PICNIC	1996	2003
PICNIC	2003	2008
PREVIA	2000	2003
PREVIA	2003	2008
PRIUS	2000	2003
RAV 4	2005	2012
REIZ	2005	
T.U.V.	2003	
TARAGO	2003	2008
VIOS	2007	
WISH	2004	2009
TOYOTA JAPAN	→ →	
ALPHARD	2003	2005
dB	2000	2005
CALDINA	2002	2004
COROLLA FIELDER	2004	
COROLLA RUNX	2004	
COROLLA SPACIO	2003	
DYNA	2008	2011
ESTIMA	2001	2003
ESTIMA	2003	
FUN CARGO	2003	2005
GAIA	1999	2004
IPSUM	1996	2003
IPSUM	2003	
ISIS	2003	
IST	2003	
KLUGER	2001	2003
KLUGER	2003	2007
LAND CRUISER PRADO	2002	2002
LAND CRUISER PRADO	2002	2005
MARK 2	2000	2006
MARK X	2004	
NOAH	2004	
OPEN DECK	2000	2005
PLATZ	2003	2005
PRONARD	2000	2002
RAUM	2003	
RAV 4	2003	
REGIUSACE	2007	
SIENTA	2003	
TOYOACE	2008	
VANGUARD	2005	
VEROSSA	2001	2004
VITZ	2003	
VOXY	2004	
WISH	2003	

TOYOTA USA	→ →	
4RUNNER	1999	2002
4RUNNER	2003	2010
AVALON	1998	2004
AVALON	2005	2011
AVANZA	2004	
CAMRY	1998	2004
CAMRY	2003	2010
COROLLA	2005	2010
FJ CRUISER	2007	2010
HIACE	2006	2013
HIGHLANDER	2001	2003
HIGHLANDER	2004	2010
LAND CRUISER	1998	2002
LAND CRUISER	2003	2008
MATRIX	2005	2010
PRIUS	2001	2003
PRIUS	2004	2008
RAV 4	2006	2010
SEQUOIA	2001	2002
SEQUOIA	2003	2010
SIENNA	1999	2003
SIENNA	2004	2010
SOLARA	2002	2003
SOLARA	2004	2010
TACOMA	2005	2010
TUNDRA	2005	2010
VENZA	2009	2010
YARIS	2007	2011

TOY41RATE



For: **TOYOTA** → →
ECHO 1999 2005
STARLET 1997 1999
TOYOTA JAPAN → →
PLATZ 1999 2002

TOY40BTE



For: **LEXUS** → →
CELSIOR [J] 1997 2000
ES300 1998 2001
LAND CRUISER [J] 1999
LS400 1997 2000
LX450 1998 2002
LX470 1999 2000
SC300/400 1998 2003
MITSUBISHI → →
MAGNA 1999 2005
VERADA (AUS) 2000 2002
TOYOTA
CENTURY 1998
LAND CRUISER 100 1998 2002
TOYOTA JAPAN → →
CELSIOR 1998 2004

TOY41RTE



For: **DAIHATSU** → →
CHARADE 1998 2004
COPEN 2002
CUORE 1998 2006
CUORE 2007
FEROZA 1995 1998
MATERIA 2006
SIRION 1998 2004
SIRION 2005
TERIOS 1997 2005
TERIOS 2006
TREVIS 2007
YRV 2000 2005
PERODUA → →
KEMBARA 1998 2008
MYVI 2006
NAUTICA 2007 2010
VIVA 2007 2014
TOYOTA → →
MR2 1997 2007
YARIS 1999 2005
TOYOTA USA → →
MR2 2001 2005

TOY43RATE



For: **HOLDEN** → →
COLORADO 2008
ISUZU → →
D-MAX 2007

TOY43TE



For: **TOYOTA** → →
AVENSIS 2000 2011
CARINA 1996 2000
CELICA 1996 2000
COROLLA 1996 2006
RAV 4 1996 2004
URBAN CRUISER 2009

TOY46RTE



For: **TOYOTA** → →
COROLLA 1996 1999

TOY47TE

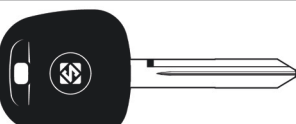

For: **DAIHATSU** → →
CHARADE 2011
TOYOTA → →
AURIS (EU) 2007 2012
AVENSIS 1998 2000
AVENSIS 2000 2003
AVENSIS 2003
CARINA 1996 2000
COROLLA 1999 2006
COROLLA 2004 2009
COROLLA (S.Africa) 2008
YARIS 1999 2005
YARIS 2005 2011

TOY48BTE



For: **LEXUS** → →
ALTEZZA [J] 1999 2005
ES300 2002 2003
ES330 2004 2007
GS/LS/LX 1998 2005
GS300 1998 2005
GS300 2005 2007
GS300/400 [J] 1998 2005
GS400 1998 2001
GS430 2001 2005
GS430 2005 2007
GX470 2003 2007
IS200 1999 2005
IS300 2001 2005
LS200 1999 2005
LS400 1999 2003
LS430 2001 2006
LX470 2001 2002
LX470 2003 2008
RX300 1999 2003
RX330 2004 2009
RX350 2004 2011
RX400h 2005 2009
RX450h 2010
SC430 2002 2010
TOYOTA → →
LAND CRUISER 100 2000 2002
LAND CRUISER 100 (AUS) 2003
TOYOTA JAPAN → →
ARISTO 1998 2005
BREVIS 2001 2007
CELSIOR 1998 2004
CROWN 1999 2005
LAND CRUISER PRADO 2000 2002
ORIGIN 2000
PROGRES NC300 1998 2006
WINDOM 2001 2004

VAC102TE



For: **RENAULT** → →
KANGOO 2002 2010
TWINGO 2002 2007
RENAULT-DACIA → →
DUSTER 2010 2013
LOGAN 2006 2012
SANDERO 2008 2013

Look A Like Keys



VA2TE



For:

CITROËN		
BERLINGO	2002	2014
C1	2004	2010
C2	2003	
C3	2002	
C3 PICASSO	2008	
C4	2005	
C5	2006	2008
C6	2005	2012
DS3	2010	
DS4	2011	
NISSAN		
NV400	2011	

OPEL-VAUXHALL

MOVANO	2011	
NISSAN		
NV400	2011	
PEUGEOT		
107	2005	2014
407	2004	2011
508	2011	
1007	2004	2010
PARTNER	2002	
RANCH	2002	2007
RENAULT		
CLIO III	2006	
KANGOO	2011	
MASTER	2011	
MODUS	2004	
TWINGO	2007	
SMART		
FORTWO	2009	
TOYOTA		
AYGO	2005	2014

YH35RATE

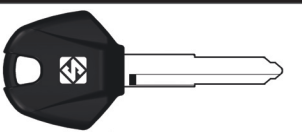

For:

YAMAHA		
BT1100 BullDog	2005	
FJ-09	2015	
FJR1300	2005	
FZ1	2006	
FZ6	2004	2011
FZ-07	2013	
FZ8	2010	
FZS1000 FAZER	2005	
Majesty 400	2005	
MT-01	2005	
MT-03	2006	2013
MT-07	2013	
MT-09	2013	
MT-09 TRACER		
TDM600	2005	
T-MAX 500	2005	2014
XJR 1300	2004	
XT660Z Ténéré	2008	
XT1200Z Super Ténéré	2010	
XTR	2004	
XTX	2004	
XVS650A DragStar	2004	2006
XVS1100A DragStar	2004	
YZF-R1	2005	
YZF-R6	2003	

ZD24RTE



For:

HONDA		
SH300	2007	
TRIUMPH		
TIGER	2010	
YAMAHA		
X-MAX 125	2006	

Special Keys Range



Silca Diamond Keys

UNIQUE, EXCLUSIVE, LUMINOUS



Silca Universal Flip Keys now available in 10 Colours



PIN FIXING TOOL

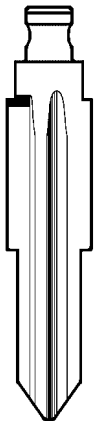

DWO4RFH
CHEVROLET

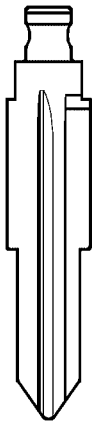

DWO5FH
CHEVROLET

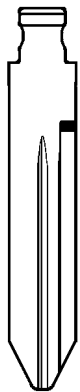

CY24FH
CHRYSLER

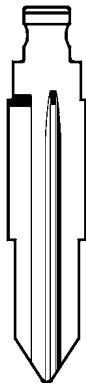

DH5RFH
DAIHATSU



FO21FH
FORD



FO10FH
FOR EU

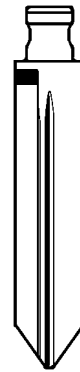

FO38RFH
FORD USA

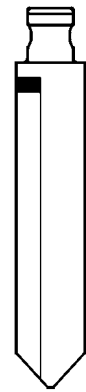

FO26FH
FORD USA

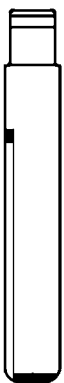

GM45FH
GEBERAK NITIRS



HON58RFH
HONDA



HON66FH
HONDA

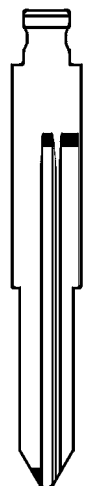

HON70FH
HONDA



HU56RFH
HUF

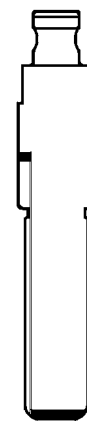

HU66FH
WITTE HUF

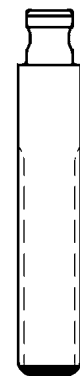

HU83FH
VALEO HUF



HU43FH
YMOS HUF

SILCA Universal Flip Key Blades



BLADES

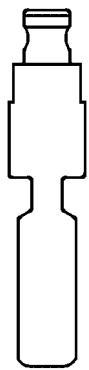

HU71FH
HUF



HU100FH
HUF



HU101FH
HUF



HU46FH
HUF

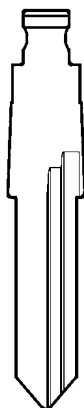

HU49FH
WITTE
HUF



HU133RFH
HUF

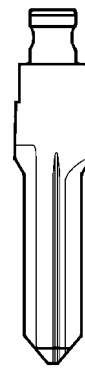

HU136FH
HUF



HYN7RFH
HYUNDAI

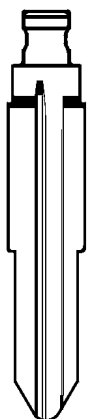

HYN10FH
HYUNDAI

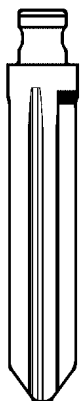

HYN14FH
HYN14RFH
HYUNDAI

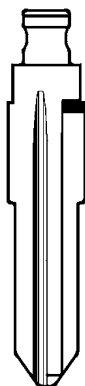

HYN15FH
HYUNDAI

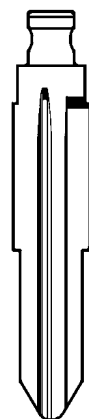

HYN6FH
HYUNDAI

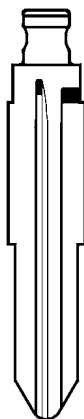

HYN12FH
HYUNDAI



KW16FH
KAWASAKI

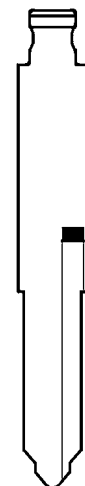

KW14FH
KAWASAKI



KIA3RFH
KIA

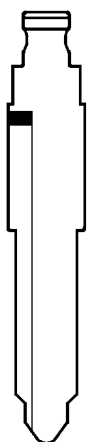

MAZ24RFH
MAZDA

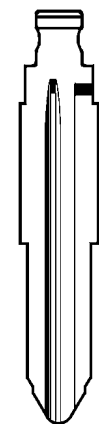

MIT8FH
MITSUBISHI

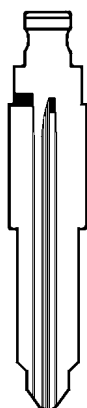

MIT11RFH
MITSUBISHI



NSN11FH
VALEO
NISSAN

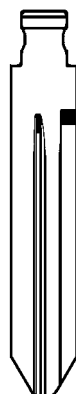

NSN14FH
VALEO
NISSAN

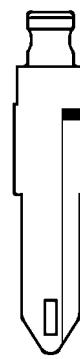

NE73FH
VALEO
NEIMAN



SSY3FH
SSANGYONG

SILCA Universal Flip Key Blades

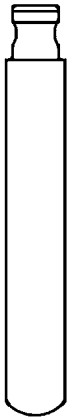

DAT17FH
SUBARU



SZ11FH
SZ11RFH
SUZUKI

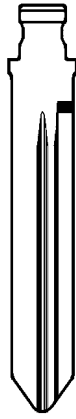

SZ18FH
SZ18RFH
SUZUKI

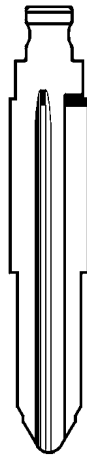

SZ12FH
SUZUKI



SZ22FH
SUZUKI

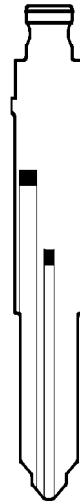

SZ17RFH
SUZUKI



TAT1FH
TATA

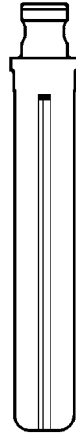

TOY40FH
TOYOTA



TOY48FH
TOYOTA



TOY49FH
TOYOTA



TOY41RFH
TOYOTA

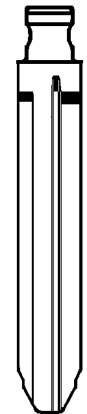

TOY43FH
TOY43RFH
TOYOTA



TOY46RFH
TOYOTA

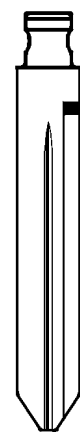

TOY47FH
TOYOTA

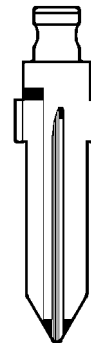

GT10FH
TRW SIPEA

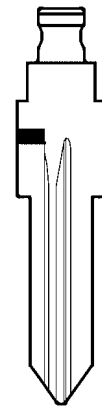

GT15RFH
GIOBERT
TRW SIPEA



SIP22FH
GIOBERT
TRW SIPEA



VAC102FH
VACHETTE

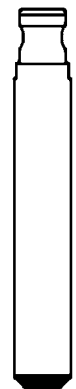

VA2FH
VALEO



VA6FH
VALEO



YH35RFH
YAMAHA

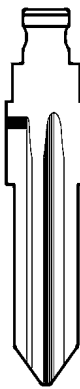

YM28FHV
ALEO
YMOS

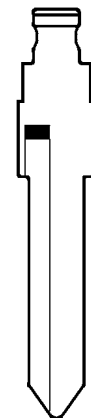

YM15FH
YMOS

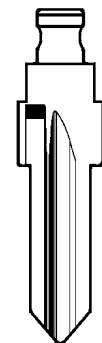

ZD24RFH
ZADI

New Designs Universal Flip Keys (2 Wheelers)



BLADES

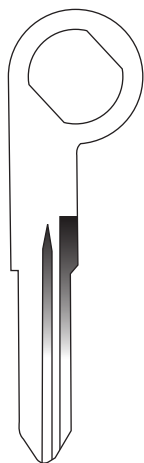

BAJ-17
DISCOVER
(BAJAJ)

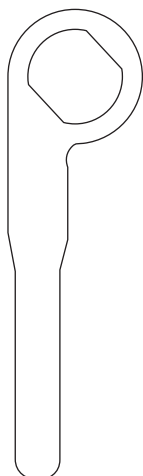

BAJ-98
PULSAR 220
(BAJAJ)

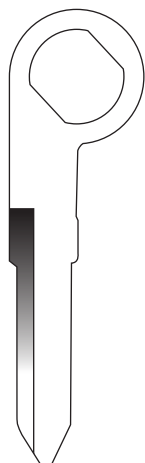

HRO1R
PASSION-R
(HERO)

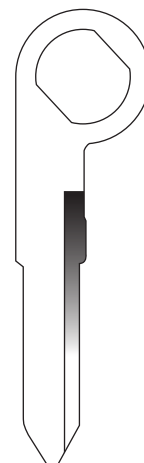

HRO1L
PASSION-L
(HERO)

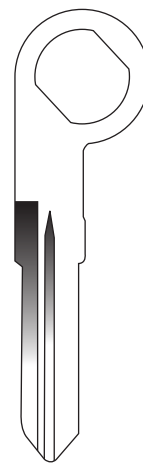

HON-62
SHINE
(HONDA)



HON-8L
UNICORN
(HONDA)

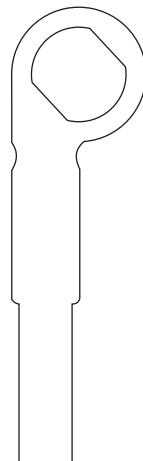

OKI-41
ELECTRIC
(OKINAWA)

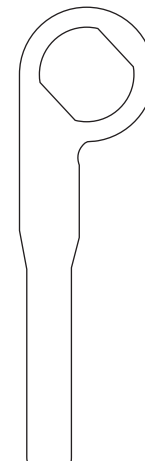

RE-98
INTERCEPTOR 650
(ROYAL ENFIELD)

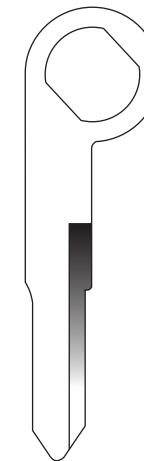

RE-72
CLASSIC 350-L
(ROYAL ENFIELD)



RE-71
CLASSIC 350-R
(ROYAL ENFIELD)

Blades For Universal Flip Keys



BLADES



TVS-91
JUPITER
(TVS)



TVS-80
NTORQ
(TVS)



TVS-21
STAR CITY-R
(LONG)
(TVS)

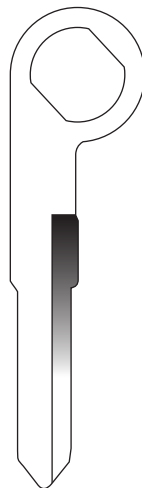

TVS-9
STAR CITY-L
(LONG)
(TVS)



TVS-300
REDEON
(TVS)



TVS-89
APACHE-L
(LONG)
(TVS)



TVS-99
APACHE-R
(LONG)
(TVS)



YMR-15
R15
(YAMAHA)



C-FLP 01

C-FLP 02



BLADES



T7325
OPTRA
(CHEVROLET)



T7326
OPTRA
(CHEVROLET)



T7360
ECOSPORT
(FORD)



T7312
LINEA
(FIAT)



T7294
HONDA CITY
(OLD)
(HONDA)



T7328
CITY/CIVIC
CR-V
(HONDA)



T7307
VERNA
(HYUNDAI)



T7310
i10
(HYUNDAI)



T7298
MICRA (K & X)
(NISSAN)



T7314
i20
(HYUNDAI)



T7359
i20 Elite (New)
(HYUNDAI)



T7369
SANTRO
(HYUNDAI)



T7418
VERNA (NEW)
(HYUNDAI)



T7374
D-MAX
(ISUZU)



T7370
SELTOS
(KIA)



T7338
TUV
(MAHINDRA)

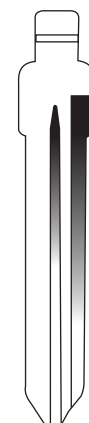

T7367
MARAZOO
(MAHINDRA)

Blades For Universal Remotes

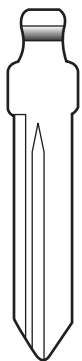

T7296
BOLERO
(MAHINDRA)



T7321
BOLERO
SINGLE LINE
(MAHINDRA)



T7336
SCORPIO
(MAHINDRA)



T7295
XYLO
(MAHINDRA)



CMHN4RT
XUV 500
(MAHINDRA)



T7304
ALTO
(NEW 800)
(MARUTI)

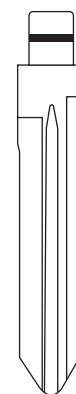

T7323
VAN
(MARUTI)

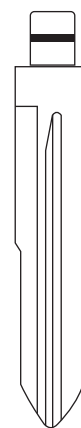

T7329
ZEN
(MARUTI)

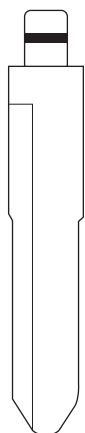

T7343
WAGON R 2019
(MARUTI)



T7302
ALTO
(MARUTI)

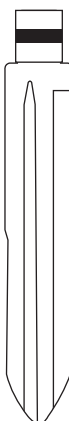

T7303
ALTO (OLD)
(MARUTI)

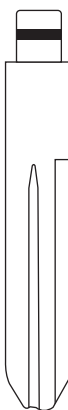

T7298
MICRA
(NISSAN)

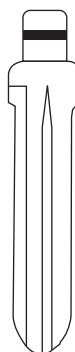

T7373
TERRANO
(NISSAN)

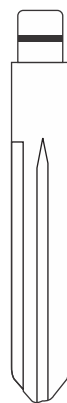

T7456
MAGNITE
(NISSAN)

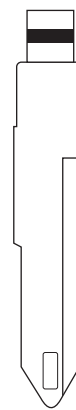

T7327
106
(PEUGEOT)



T7364
DUSTER
(RENAULT)



T7358
KWID
(RENAULT)

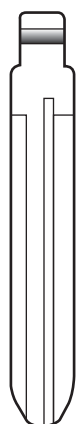

T7297
INNOVA (K&X)
(TOYOTA)

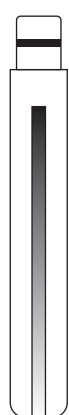

T7308
LEXUS
(TOYOTA)

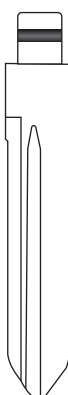

T7313
SAFARI
(TATA)



T7322
SUMO
(TATA)



T7339
INDICA
(TATA)



T7309
NEXON
(TATA)

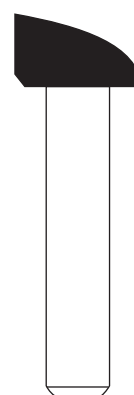

T7459
NEXON
(TATA)
(EMERGENCY
BLADE)



The range of Silca proximity, slot and remote car keys is the perfect solution for replacing damaged or lost keys, or to have a duplicate in case of emergency. All the keys have a similar design as the original and are supplied ready-to-programme with the PCB, transponder and emergency or flip blade included. The keys can be programmed with Smart Pro and other programming devices and are packed individually in a plastic clamshell for easy identification and hook display

Buttons

	1 Button		2 Buttons		3 Buttons
	4 Buttons		5 Buttons		Lock
	Unlock		Boot		Light
	Red Panic Button		Hazard Lights		

Frequency

	433,92 MHz		868,35 MHz
--	------------	--	------------

Transponder

	Transponder type ID46		Transponder type ID47
	Transponder type ID49-1E		Transponder type ID6E-63

For : BMW® HU131RS05



Make	Model	Chassis	From	To	Blade
BMW®	1 Series	E81; E82; E87; E88	2004	2013	HU92R
BMW®	3 Series	E90; E91; E92; E93	2005	2013	HU92R
BMW®	5 Series	E60; E61	2003	2010	HU92R
BMW®	6 Series	E63; E64	2004	2010	HU92R
BMW®	X1	E84	2009	2012	HU92R
BMW®	X5	E70	2007	2013	HU92R
BMW®	X6	E71	2008	2013	HU92R
BMW®	Z4	E89	2009	2012	HU92R

Proximity Keys



For : FIAT® SIP22R01



Make	Model	Chassis	From	To	Blade
Abarth®	500	199	2008		SIP22
Abarth®	Grande Punto	199	2007	2010	SIP22
Abarth®	Punto	199	2012	2014	SIP22
Abarth®	Punto Evo	199	2010	2012	SIP22
Alfa Romeo®	MiTo	955	2008		SIP22
Chrysler®	Ypsilon		2011		SIP22
Citroën®	Nemo		2008		SIP22
Fiat®	500	312	2007		SIP22
Fiat®	Doblò	263	2009		SIP22
Fiat®	Fiorino	225	2007		SIP22
Fiat®	Grande Punto	199	2005	2012	SIP22
Fiat®	Panda	312	2011		SIP22
Fiat®	Punto	199	2012		SIP22
Fiat®	Punto Evo	199	2009	2012	SIP22
Fiat®	Qubo	225	2008		SIP22
Ford® Europe	Ka	RU	2008	2016	SIP22
Lancia®	Ypsilon	312; 846	2011		SIP22
Opel®-Vauxhall®	Combo		2012	2017	SIP22
Peugeot®	Bipper		2009		SIP22

For : FIAT® SIP 22R31



Make	Model	Chassis	From	To	Blade
Alfa Romeo®	147	ZAR937	2001	2009	SIP22
Alfa Romeo®	GT	ZAR937	2004	2010	SIP22
Citroën®	Jumper	250	2006	2009	SIP22
Citroën®	Relay	VF7YC	2006	2009	SIP22
Fiat®	Bravo	ZFA198	2007	2008	SIP22
Fiat®	Ducato	250	2006	2009	SIP22
Fiat®	Idea	350	2002	2007	SIP22
Fiat®	Linea	323	2007	2015	SIP22
Fiat®	Stilo	192	2001	2007	SIP22
Lancia®	Ypsilon	843	2003	2010	SIP22
Lancia®	Musa	350	2004	2008	SIP22
Peugeot®	Boxer	250	2006	2009	SIP22

For : FIAT® SIP 22R07



Make	Model	Chassis	From	To	Blade
Alfa Romeo®	Giulietta	940	2010		SIP22
Citroën®	Jumper		2009		SIP22
Citroën®	Relay		2009		SIP22
Dodge®	Promaster		2014	2018	SIP22
Fiat®	500L	330	2012		SIP22
Fiat®	Bravo	198	2007	2015	SIP22
Fiat®	Ducato	250	2009		SIP22
Iveco®	Daily	300	2012		SIP22
Lancia®	Delta	844	2008	2014	SIP22
Lancia®	Musa	350	2009	2012	SIP22
Lancia®	Ypsilon	312; 846	2011		SIP22
Peugeot®	Boxer		2009		SIP22

For : FORD® HU101R10



Make	Model	Chassis	From	To	Blade
Ford®	B-Max	JK8	2012	2018	HU101
Ford®	C-Max	DM2	2003	2010	HU101
Ford®	Ecosport	JK8	2012	2016	HU101
Ford®	Fiesta	JAB/JHH	2008	2012	HU101
Ford®	Fiesta	JAB/JHH	2011	2017	HU101
Ford®	Focus	DA/DB	2004	2010	HU101
Ford®	Galaxy	WA6	2006	2011	HU101
Ford®	Kuga		2008	2012	HU101
Ford®	Mondeo	BA7	2007	2011	HU101
Ford®	S-Max	WA6	2006	2010	HU101

For : FORD® HU198P15



Make	Model	Chassis	From	To	Blade
Ford®	C-Max	CEU	2015		HU198
Ford®	Focus	CEW	2014	2018	HU198
Ford®	Kuga	CBS	2016		HU198

Proximity Keys



For : FORD® HU198P14



Make	Model	Chassis	From	To	Blade
Ford®	B-Max	CB2	2012		HU198
Ford®	C-Max	CB7	2010	2015	HU198
Ford®	Fiesta	CB1	2008	2012	HU198
Ford®	Fiesta	CCN	2011	2017	HU198
Ford®	Focus	CB8	2011	2015	HU198
Ford®	Galaxy	CA1	2010	2015	HU198
Ford®	Kuga	CBS	2011	2016	HU198
Ford®	Mondeo	CA2	2007	2010	HU198
Ford®	Mondeo	CA2	2011	2014	HU198
Ford®	S-Max	CA1	2010	2015	HU198

For : FORD® HU101AR24



Make	Model	Chassis	From	To	Blade
Ford®	C-Max	CB7	2010	2015	HU101
Ford®	C-Max	CEU	2015		HU101
Ford®	Focus	CB8	2011	2015	HU101
Ford®	Focus	CEW	2014	2019	HU101
Ford®	Galaxy	CA1	2010	2015	HU101
Ford®	Mondeo	CA2	2011	2014	HU101
Ford®	Ranger	TKE	2011	2015	HU101
Ford®	S-Max	CA1	2010	2015	HU101
Ford®	Tourneo Connect	CHC	2013		HU101
Ford®	Transit Connect	CHC	2013		HU101

For : FORD® FO21R10



Make	Model	Chassis	From	To	Blade
Ford®	Fiesta	JD3/JH1	2003	2008	FO21
Ford®	Focus	DAW/DBW/DNW	1998	2004	FO21
Ford®	Fusion	JU2	2002	2012	FO21
Ford®	Mondeo	B4Y/B5Y/BWY	2001	2006	FO21
Ford®	Tourneo Connect		2002	2008	FO21
Ford®	Tourneo Connect		2009	2013	FO21
Ford®	Transit	V184/5	2000	2006	FO21
Ford®	Transit Connect		2002	2008	FO21
Ford®	Transit Connect		2009	2013	FO21

For : HYUNDAI* KIA8P28



Make	Model	Chassis	From	To	Blade
Hyundai®	IX35	EL	2013	2015	KIA8
Hyundai®	Tucson		2013	2015	KIA8

For : HYUNDAI* KIA8R32



Make	Model	Chassis	From	To	Blade
Hyundai®	IX35	EL	2013	2015	433FM
Hyundai®	Tucson	EL	2013	2015	433FM

For : JEEP* CY24P21



Make	Model	Chassis	From	To	Blade
Jeep®	Cherokee	KL	2014		CY24

For : JEEP* SIP22P40



Make	Model	Chassis	From	To	Blade
Jeep®	Compass	552 (MP)	2014		SIP22

For : KIA* KIA8R28



Make	Model	Chassis	From	To	Blade
Kia®	Sportage	SL	2010	2013	KIA8
Kia®	Sportage	SL	2013	2015	KIA8

Proximity Keys



For : LAND ROVER* HU188S16



Make	Model	Chassis	From	To	Blade
Land Rover®	Freelander 2	LF	2006	2012	HU101

For : MAZDA* MAZ25RP32



Make	Model	Chassis	From	To	Blade
Mazda®	2	DJ	2014	2020	MAZ25R
Mazda®	3	BM/BN	2013	2019	MAZ25R
Mazda®	6	GJ/GL	2012	2020	MAZ25R
Mazda®	CX-3	DK	2015	2020	MAZ25R
Mazda®	CX-5	KE	2012	2020	MAZ25R

For : MAZDA* MAZ25RP31



Make	Model	Chassis	From	To	Blade
Mazda®	6	GJ/GL	2012	2020	MAZ25R
Mazda®	CX-5	KE	2012	2017	MAZ25R
Mazda®	MX-5	ND	2015	2020	MAZ25R

For : MERCEDES* HU106S23



Make	Model	Chassis	From	To	Blade
Mercedes®	A-Class	W169	2004	2012	HU106
Mercedes®	A-Class	W176	2012	2014	HU106
Mercedes®	B-Class	W245	2005	2011	HU106
Mercedes®	B-Class	W246	2011	2014	HU106
Mercedes®	C-Class	W203	2000	2008	HU106
Mercedes®	C-Class	W204	2007	2014	HU106
Mercedes®	CL	W215	1999	2006	HU106
Mercedes®	CL	C216	2006	2013	HU106
Mercedes®	CLA	C117	2013	2014	HU106
Mercedes®	CLK	W208	1997	2002	HU106
Mercedes®	CLK	W209	2003	2010	HU106
Mercedes®	CLS	C219	2004	2010	HU106
Mercedes®	CLS	C218	2010	2014	HU106
Mercedes®	E-Class	W210	1996	2002	HU106
Mercedes®	E-Class	W211	2002	2009	HU106
Mercedes®	E-Class	W212	2010	2014	HU106
Mercedes®	G-Wagon	W463	2000	2007	HU106
Mercedes®	GLA	X156	2013	2014	HU106
Mercedes®	M-Class	W164	2005	2011	HU106
Mercedes®	M-Class	W166	2011	2014	HU106
Mercedes®	R-Class	W251	2005	2013	HU106
Mercedes®	S-Class	W220	1998	2005	HU106
Mercedes®	S-Class	W221	2005	2013	HU106
Mercedes®	SL	R230	2001	2005	HU106
Mercedes®	SL	R230	2005	2011	HU106
Mercedes®	SLK	R171	2004	2011	HU106
Mercedes®	SLK	R172	2011	2014	HU106
Mercedes®	SLS	R197	2010	2014	HU106
Mercedes®	Sprinter	W906	2006	2018	HU106
Mercedes®	Viano	W639	2003	2014	HU106
Mercedes®	Vito	W639	2003	2014	HU106

For : NISSAN® NSN14P01



Make	Model	Chassis	From	To	Blade
Nissan®	Qashqai	J11	2014	2017	NSN14
Nissan®	X-Trail	T32	2014	2017	NSN14

Proximity Keys



For : NISSAN* NSN14R14



Make	Model	Chassis	From	To	Blade
Nissan®	Cabstar	F24	2006	2013	NSN14
Nissan®	Micra	K12	2002	2010	NSN14
Nissan®	Navara	D40	2005	2015	NSN14
Nissan®	Note	E11	2006	2013	NSN14
Nissan®	NV200	M20	2009	2013	NSN14
Nissan®	Pathfinder	R51	2005	2014	NSN14
Nissan®	Qashqai	J10	2007	2014	NSN14
Nissan®	Tiida	C11	2006	2013	NSN14
Renault®	Maxity		2006	2013	NSN14

For : NISSAN* NSN14P30



Make	Model	Chassis	From	To	Blade
Nissan®	Frontier	D23X	2014	2020	NSN14
Nissan®	Juke	F15N/F15E	2010	2019	NSN14
Nissan®	Micra	K13K	2010	2015	NSN14
Nissan®	Navara	D23M	2015	2020	NSN14
Nissan®	Note	E12E	2013	2020	NSN14
Nissan®	NP300	D23T	2014	2020	NSN14
Nissan®	NV200	M20M	2010	2017	NSN14
Nissan®	Tiida	C13R/C13Z	2015	2020	NSN14

For : NISSAN® NSN14P04



Make	Model	Chassis	From	To	Blade
Nissan®	Pulsar	C13	2014		NSN14
Nissan®	Qashqai	J11	2014	2017	NSN14
Nissan®	X-Trail	T32	2014	2017	NSN14

For : OPEL® HU100R01

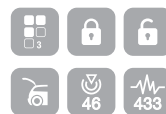

Make	Model	Chassis	From	To	Blade
Chevrolet®-Daewoo®	Cruze	J300-PD (JA. JF)	2008	2014	HU100
Chevrolet®-Daewoo®	Orlando	J309 (KL1YF)	2011	2015	HU100
Opel®-Vauxhall®	Astra	J	2009	2015	HU100
Opel®-Vauxhall®	Insignia	A	2008	2017	HU100

For : OPEL® HU100R02



Make	Model	Chassis	From	To	Blade
Chevrolet®-Daewoo®	Aveo	T300 (TA, TF)	2011		HU100
Chevrolet®-Daewoo®	Cruze	J300-PD (JA. JF)	2008	2014	HU100
Chevrolet®-Daewoo®	Orlando	J309 (KL1YF)	2011	2015	HU100
Chevrolet®-Daewoo®	Spark	M400	2015		HU100
Opel®-Vauxhall®	Adam		2013		HU100
Opel®-Vauxhall®	Astra	J	2009	2015	HU100
Opel®-Vauxhall®	Cascada		2013		HU100
Opel®-Vauxhall®	Corsa	E	2014		HU100
Opel®-Vauxhall®	Insignia	A	2008	2017	HU100
Opel®-Vauxhall®	Mokka		2012		HU100
Opel®-Vauxhall®	Zafira	C	2013		HU100

For : OPEL-VAUXHALL* HU100AR02



Make	Model	Chassis	From	To	Blade
Opel-Vauxhall®	Astra	H	2004	2011	HU100
Opel-Vauxhall®	Zafira	B	2005	2014	HU100

For : OPEL-VAUXHALL* HU100R26



Make	Model	Chassis	From	To	Blade
Opel-Vauxhall®	Corsa	D (S07)	2012	2014	HU100
Opel-Vauxhall®	Meriva	B (M9)	2010	2014	HU100

Proximity Keys



For : OPEL-VAUXHALL* HU100R23



Make	Model	Chassis	From	To	Blade
Opel-Vauxhall®	Astra	K	2016		HU100

For : PSA* VA-P25



Make	Model	Chassis	From	To	Blade
Citroën®	C4 Picasso	B78	2013	2016	HU83
Citroën®	DS5	B81	2011	2016	VA2
Peugeot®	308	T9 (VF3L)	2013	2016	HU83
Peugeot®	508	W2 (VF38)	2010	2016	VA2

For : PSA* VA-R16



Make	Model	Chassis	From	To	Blade
Citroën®	Berlingo	B9	2009	2014	VA2
Citroën®	C2	MY60 VF7J	2005	2009	VA2
Citroën®	C3	A51 VF7F	2005	2009	VA2
Citroën®	C3	A51 VF7S	2009	2016	VA2
Citroën®	C3 Picasso	A58	2008	2017	VA2
Citroën®	C3 Pluriel	VF7F	2005	2009	VA2
Citroën®	C4 Picasso		2006	2013	HU83
Citroën®	C4 Picasso		2006	2013	HU83
Citroën®	C5	X9 VF7R	2006	2011	HU83
Citroën®	C8	U65 VF7B	2005	2009	HU83
Citroën®	C8	V3 VF7E	2009	2014	HU83
Citroën®	Dispatch	G9 VF7X	2007	2009	HU83
Citroën®	Dispatch		2009	2016	HU83
Citroën®	DS3	A55 VF7S	2009	2016	VA2
Citroën®	Jumpy	VF7X	2009	2016	HU83
Fiat®	Scudo	272	2007	2009	HU83
Fiat®	Scudo	272	2009	2016	HU83
Fiat®	Ulysse	179	2005	2009	HU83
Fiat®	Ulysse	179	2009	2011	HU83
Lancia®	Phedra	179	2006	2010	HU83
Peugeot®	207		2009	2012	HU83
Peugeot®	307	T5 VF33	2007	2008	HU83
Peugeot®	308	T7 VF34	2007	2008	HU83
Peugeot®	308	T8 VF34	2010	2013	HU83
Peugeot®	807	V2 VF3E	2005	2009	HU83
Peugeot®	807	V2 VF3E	2009	2014	HU83
Peugeot®	3008	T84 VF30	2009	2013	HU83
Peugeot®	5008	VF30E	2009	2013	HU83
Peugeot®	Expert	G9 VF3X	2007	2009	HU83
Peugeot®	Expert	VF3X	2009	2016	HU83
Peugeot®	Partner	VF35	2008	2013	VA2
Peugeot®	RCZ	T75 (VF34J)	2011	2015	HU83
Toyota®	Proace	YARVE	2013	2016	HU83

For : PSA* VA2R27



Make	Model	Chassis	From	To	Blade
Citroën®	C1	MY70/CB0 (VF3PM/N)	2005	2014	VA2
Peugeot®	107	(VF3PM/N)	2005	2014	VA2
Toyota®	Aygo	KGB10	2005	2014	VA2

For : PSA* VA-P36



Make	Model	Chassis	From	To	Blade
Citroën®	C4 Spacetourer	3A/3E/3D	2018	2020	HU83
Citroën®	Jumpy	E3 (VF7P)	2016	2021	HU83
Citroën®	Spacetourer	VF7V	2016	2021	HU83
Opel-Vauxhall®	Vivaro	VXEVB K0	2019	2021	HU83
Opel-Vauxhall®	Zafira Life	K0	2019	2021	HU83
Peugeot®	508	FE/FB	2018	2020	VA2
Peugeot®	3008	P84	2016	2019	HU83
Peugeot®	5008	P87	2016	2019	HU83
Peugeot®	Expert	K0 (VF3V)	2016	2021	HU83
Peugeot®	Traveller	K0 (VF7V)	2016	2021	HU83

Proximity Keys



For : PSA* HU83R21



Make	Model	Chassis	From	To	Blade
Citroën®	C4 Cactus	E3 (VF70)	2014	2018	HU83
Peugeot®	208	A9 (VF3CA8/C)	2012	2019	HU83
Peugeot®	301		2013	2016	HU83
Peugeot®	308	T9 (VF3L)	2014	2020	HU83
Peugeot®	2008	A94 (VF3C)	2013	2019	HU83

For : TOYOTA* TOY49R25



Make	Model	Chassis	From	To	Blade
Citroën®	C1	B4 (VF7P)	2014	2021	TOY49
Peugeot®	108	B1 (VF3P)	2014	2021	TOY49
Toyota®	Aygo	KGB40	2014	2021	TOY49

For : RENAULT-DACIA* RNR01



Make	Model	Chassis	From	To	Blade
Nissan®	Interstar	X70	2004	2010	NE73
Nissan®	Kubistar	X76	2004	2005	VAC102
Nissan®	Primastar	X83	2002	2014	NE73
Opel-Vauxhall®	Movano	VN1F	2004	2010	NE73
Opel-Vauxhall®	Vivaro	X83	2002	2014	NE73
Renault-Dacia®	Clio 2	X65	2001	2008	NE73
Renault-Dacia®	Clio 3	X85	2006	2010	VA2
Renault-Dacia®	Duster	UU1HS	2010	2013	VAC102
Renault-Dacia®	Kangoo	M49/X76	2002	2004	VAC102
Renault-Dacia®	Kangoo	M49/X76	2004	2011	VAC102
Renault-Dacia®	Kangoo	M59/X61	2010	2017	VA2
Renault-Dacia®	Logan	UU1KS	2004	2012	VAC102
Renault-Dacia®	Master	X70	2004	2010	NE73
Renault-Dacia®	Master	X62	2010	2019	VA2
Renault-Dacia®	Sandero	B90	2008	2012	HU136
Renault-Dacia®	Sandero	B90	2008	2012	VAC102
Renault-Dacia®	Trafic	X83	2002	2014	NE73
Renault-Dacia®	Twingo	X33	2002	2007	VAC102
Renault-Dacia®	Twingo	X44	2007	2010	VA2
Renault-Dacia®	Wind		2010	2012	VA2

For : RENAULT® VA150S13



Make	Model	Chassis	From	To	Blade
Renault®	Captur	X87 (VF12R)	2013		VA150
Renault®	Clio 4	X87 (VF12R)	2012		VA150
Renault®	Symbol 3		2012		VA150

For : RENAULT® VA150S15



Make	Model	Chassis	From	To	Blade
Renault®	Grand Scenic 3	JZ	2009	2015	VA150
Renault®	Laguna 3	BT/DT/KT	2007	2015	VA150
Renault®	Megane 3	BZ/DZ/KZ	2008	2016	VA150
Renault®	Scenic 3	JZ	2009	2015	VA150

For : RENAULT-DACIA* RN-N01R11



Make	Model	Chassis	From	To	Blade
Fiat®	Talento	296	2016		VA2
Lada®	Vesta	GFL	2015		VA2
Lada®	XRAY	GAB	2016		VA2
Nissan®	NV300		2016		VA2
Nissan®	Pulsar	C13	2014	2016	NSN14
Nissan®	Qashqai	J11	2014	2016	NSN14
Nissan®	X-Trail	T32	2015	2017	NSN14
Opel-Vauxhall®	Vivaro	X82	2014	2019	VA2
Renault-Dacia®	Dokker	K67	2013		HU136
Renault-Dacia®	Duster	H79	2013	2016	VA2
Renault-Dacia®	Duster	H79	2013		VAC102
Renault-Dacia®	Lodgy	J92	2013		HU136
Renault-Dacia®	Logan	K/L52	2013	2016	HU136
Renault-Dacia®	Logan	K/L52	2013	2016	VA2
Renault-Dacia®	Logan	K/L52	2016		HU179
Renault-Dacia®	Sandero	B52	2013	2016	HU136
Renault-Dacia®	Sandero	B52	2013	2016	VA2
Renault-Dacia®	Sandero	B52	2016		HU179
Renault®	Trafic	X82	2014	2019	VA2
Renault®	Twingo	BCM	2014		VA2
Smart®	Forfour	453	2014	2020	VA2
Smart®	Fortwo	453	2014		VA2

Proximity Keys



For : RENAULT-DACIA* VA2P26



Make	Model	Chassis	From	To	Blade
Renault®	Espace 5		2015		VA2
Renault®	Kadjar		2015		VA2
Renault®	Koleos	HC	2016		VA2
Renault®	Megane 4		2015		VA2
Renault®	Scenic 4		2015		VA2
Renault®	Talisman		2015		VA2

For : SMART* YM23R20



Make	Model	Chassis	From	To	Blade
Smart®	Fortwo	450	2000	2007	YM23
Smart®	Roadster	452	2003	2006	YM23

For : SMART* VA2AR13



Make	Model	Chassis	From	To	Blade
Smart®	Fortwo	W451	2007	2016	VA2

For : SUZUKI HU133RR18



Make	Model	Chassis	From	To	Blade
Fiat®	Sedici	YB	2006	2014	HU133R
Opel-Vauxhall®	Agila	XB	2008	2014	HU133R
Opel-Vauxhall®	Agila (Diesel)	XB	2008	2014	HU133R
Suzuki®	Grand Vitara	JB	2006	2013	HU133R
Suzuki®	Splash	EXB	2008	2015	HU133R
Suzuki®	Swift	MZ/EZ	2005	2010	HU133R
Suzuki®	SX4	GY	2006	2012	HU133R

For : SUZUKI HU133RR19



Make	Model	Chassis	From	To	Blade
Fiat®	Sedici (Diesel)	YB	2006	2014	HU133R
Suzuki®	Splash (Diesel)	EXB	2008	2015	HU133R
Suzuki®	Swift (Diesel)	MZ/EZ	2005	2010	HU133R
Suzuki®	SX4 (Diesel)	GY	2006	2012	HU133R

For : VOLKSWAGEN GROUP

HU66R09



Make	Model	Chassis	From	To	Blade
Seat®	Alhambra	7N	2010	2016	HU66
Seat®	Altea	5P	2007	2015	HU66
Seat®	Ibiza	6J	2008	2016	HU66
Seat®	Leon	1P	2005	2013	HU66
Seat®	Mii	KF	2012	2016	HU66
Seat®	Toledo	5P	2009	2010	HU66
Škoda®	Citigo	AA	2012	2016	HU66
Škoda®	Fabia	5J	2011	2014	HU66
Škoda®	Octavia	1Z	2009	2013	HU66
Škoda®	Rapid	NH	2012	2016	HU66
Škoda®	Roomster	5J	2011	2015	HU66
Škoda®	Roomster Scout	5J	2011	2015	HU66
Škoda®	Superb	3T	2008	2013	HU66
Škoda®	Yeti	5L	2009	2013	HU66
Volkswagen®	Amarok	2H	2010	2016	HU66
Volkswagen®	Beetle	5C	2011	2016	HU66
Volkswagen®	Caddy	2K	2011	2016	HU66
Volkswagen®	Eos	1F	2010	2016	HU66
Volkswagen®	Golf	5K	2009	2013	HU66
Volkswagen®	Golf Plus	1K	2009	2014	HU66
Volkswagen®	Jetta	16	2010	2016	HU66
Volkswagen®	Polo	6R	2009	2016	HU66
Volkswagen®	Scirocco	13	2008	2010	HU66
Volkswagen®	Scirocco	13	2011	2016	HU66
Volkswagen®	Sharan	7N	2010	2016	HU66

Proximity Keys



For : VOLKSWAGEN GROUP*

HU66R09



Make	Model	Chassis	From	To	Blade
Volkswagen®	Tiguan	5N	2008	2016	HU66
Volkswagen®	Touran	1T	2011	2016	HU66
Volkswagen®	Transporter	7H	2009	2016	HU66
Volkswagen®	Up!	AA	2011	2016	HU66

For : ALFA ROMEO

SIP22AR34



Make	Model	Chassis	From	To	Blade
Alfa Romeo*	Mito*	955	2008	2019	SIP22
Alfa Romeo*	Giulietta*	940	2010	2021	SIP22

For : AUDI

HU66S04



Make	Model	Chassis	From	To	Blade
Audi*	A4*	B8/8K	2008	2016	HU66
Audi*	A5*	8F/8T	2007	2017	HU66
Audi*	S4*		2008	2016	HU66
Audi*	S5*	8F/8T	2010	2014	HU66
Audi*	Q5*	8R	2008	2017	HU66

New Silca Proximity Car Key HU101P11 compatible with Land Rover*



Make	Model	Chassis	From	To	Blade
Land Rover	Range Rover	L405	2012	2018	HU101
Land Rover	Range Rover Sport	L494	2012	2018	HU101
Land Rover	Range Rover Evoque	L2358	2011	2019	HU101
Land Rover	Discovery	L319	2012	2018	HU101
Land Rover	Discovery Sport	L550	2015	2018	HU101
Land Rover	Freelander	L359	2012	2014	HU101

For : VOLVO HU152S16



Make	Model	Chassis	From	To	Blade
Volvo®	S60	Y20	2010	2018	HU101
Volvo®	S80	AS	2006	2016	HU101
Volvo®	V40		2012		HU101
Volvo®	V60		2010	2018	HU101
Volvo®	V70	TYP B	2007	2016	HU101
Volvo®	XC60	Y20	2009	2017	HU101
Volvo®	XC70	P24	2008	2016	HU101

For : TOYOTA

TOY53AP18



Make	Model	Chassis	From	To	Blade
TOYOTA	C-HR	*X10	2017	2020	TOY53

For : FIAT

CY24AP28



Make	Model	Chassis	From	To	Blade
Fiat*	Freemont*	3E4PK	2011	2016	CY24
Jeep*	Grand Cherokee*	RJ	2014	2017	CY24

New Silca Remote Car Key SIP22R34 compatible with Fiat*



Make	Model	Chassis	From	To	Blade
Abarth*	500*	312	2008	-	SIP22
Abarth*	Grande Punto*	199	2007	2010	SIP22
Abarth*	Punto Evo*	199	2010	2012	SIP22
Abarth*	Punto*	199	2012	2014	SIP22
Chrysler*	Ypsilon*	312	2011		SIP22
Citroën*	Nemo*	X225	2007	2015	SIP22
Dodge*	Promaster City*		2015	2022	SIP22
Dodge*	Promaster*		2014	2018	SIP22



DOMESTIC KEYS



Domestic Keys



FOR DORSET / CORBIN / CESA

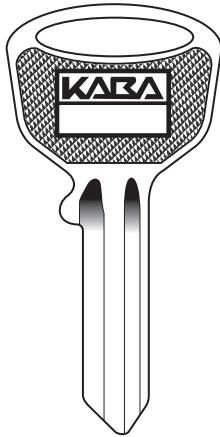

T8134
DORSET

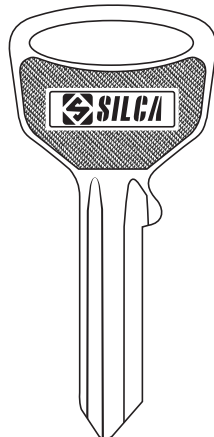

CDRS2
DORSET



CB6
CORBIN



CE6R
CESA

FOR GLOBE



GL2
2 PIN



GL7R
7 PIN



GL9
9 PIN



GL10
10 PIN



T7383
6 PIN

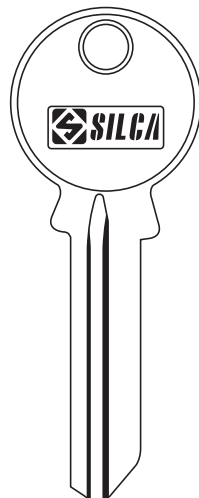

T7388
6 PIN (STEEL)

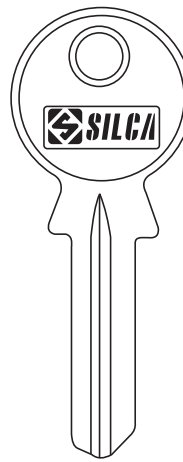

T7382
5 PIN (BRASS)

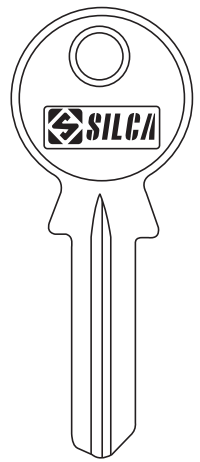

T7387
5 PIN

Domestic Keys

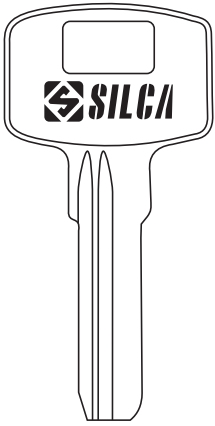

T7292
JAIWEI
SHORT
(BRASS)



T7419
JAIWEI
SHORT
(STEEL)



T7288
JAIWEI -R
(SHORT)

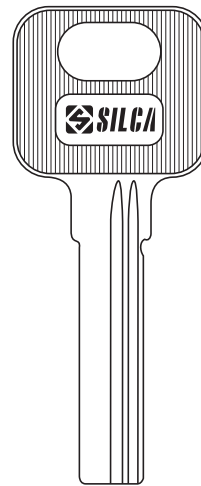

T7287
JAIWEI
LONG
(BRASS)

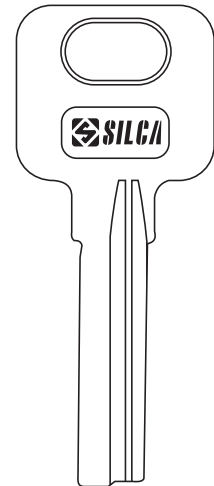

T7420
LONG
(STEEL)

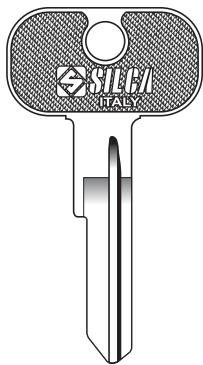

BHA1
BHARAT



T8132
KWIKSET
(STEEL)

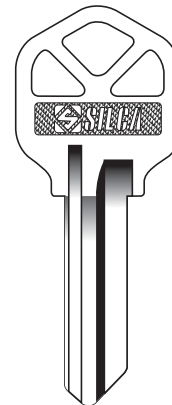

KS1
KWIKSET
(BRASS)

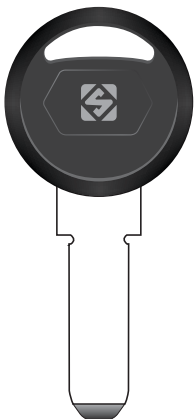

T7254
HARRISON



MC12
MCM

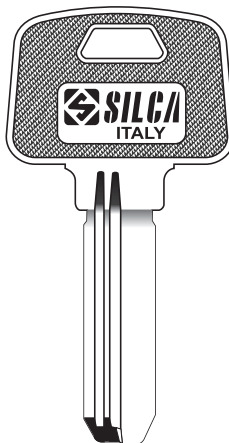

MC10R
MCM



MC15R
MCM

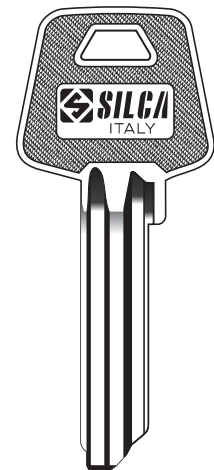

MC11
MCM

FOR JAIWEI

FOR BHARAT / KWIKSET

FOR HARRISON / MCM

Domestic Keys



FOR UNIVERSAL

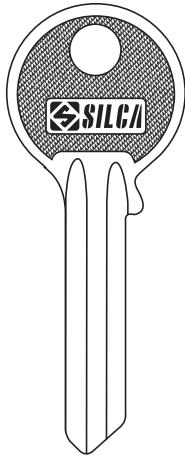

T8149
UL054

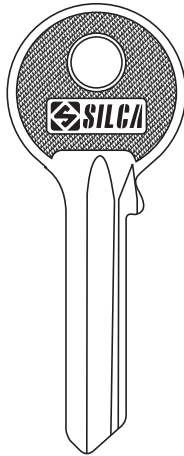

T8150
UL055

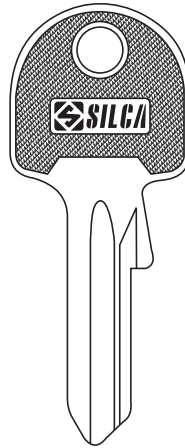

T8053
UL053SL

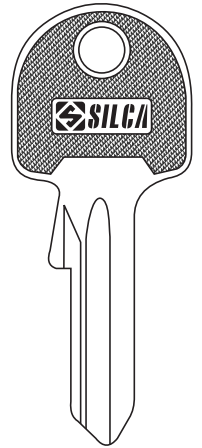

T8058
UL52SL



T8146
UL058

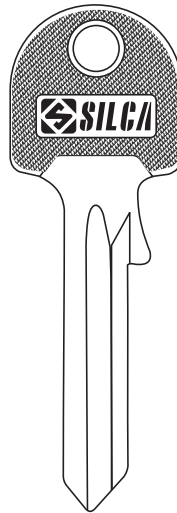

T8061
UL055SL

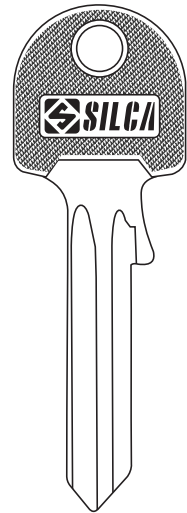

T8060
UL054SL

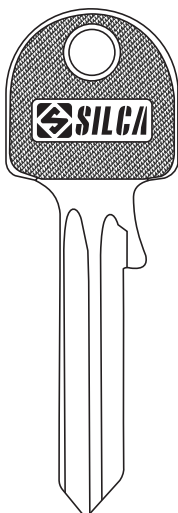

T8054
UL054SL(BRASS)

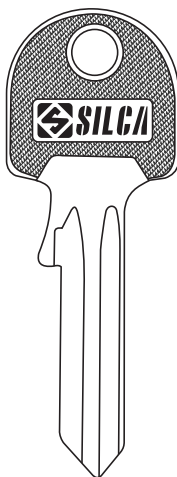

T8051
UL051SL

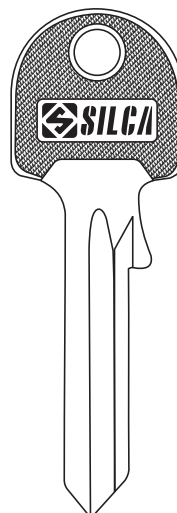

T8055
UL055SL



T8052
UL052SL

Domestic Keys



T8001
UL50



T8040
UL051

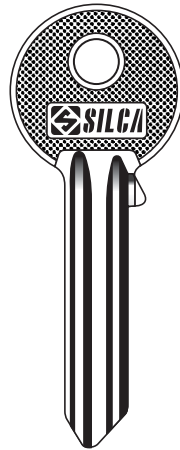

T8148
UL054



T8151
UL055

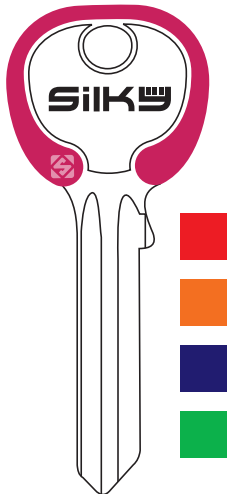

T8197
UL054DZ

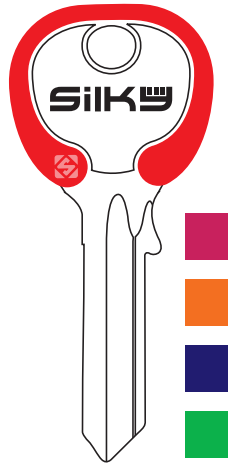

T8185
AGB1RDZ

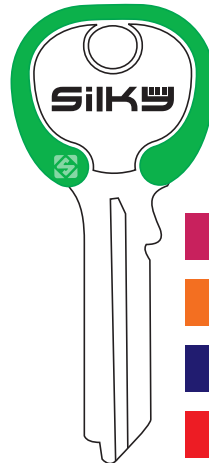

T8234
TE2DZ

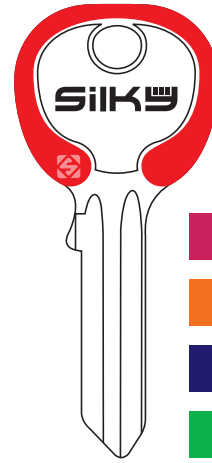

T8182
UL051DZ

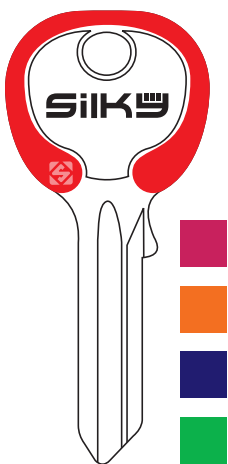

T8264
YA1DZ

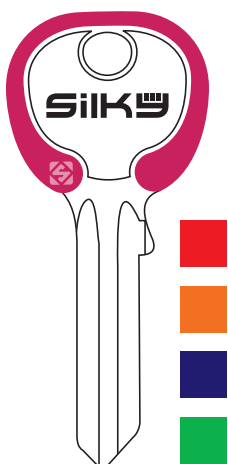

T8180
UL050DZ

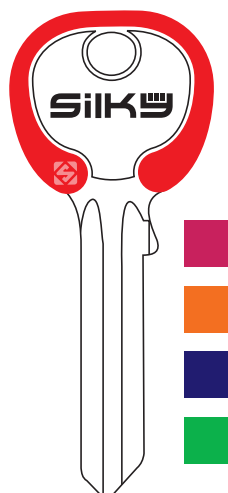

T8198
YA31DZ

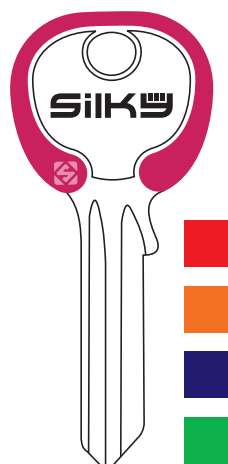

T8228
CB6DZ

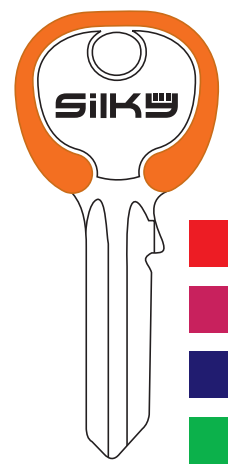

T8203
VI080DZ

FOR UNIVERSAL

Domestic Keys



FOR TESA / DOM



TE2R
TESA



TE7
TESA



TE2
TESA

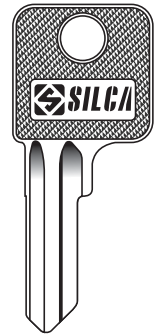

DM 16
DOM

FOR PUMA / AZBE



T7274
PUMA LOCK



AZ7
AZBE

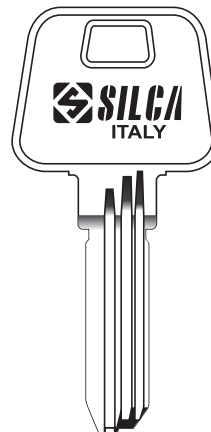

AZ6
AZBE

FOR GODREJ



T7253
ULTRA 4 LEVER



KA5
EXS



KA1
ULTRA



KA2
ULTRA

KA2 CCL
(BRASS/LACQUER
FINISH)



GJ4
6 LEVER



T7281
FREEDOM

Domestic Keys



GJSB1
DOOR LOCK
(RING)

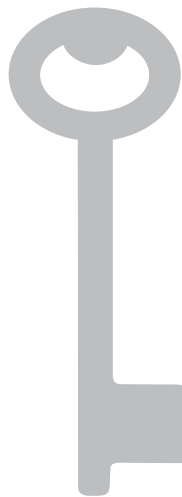

T9018
DOOR LOCK

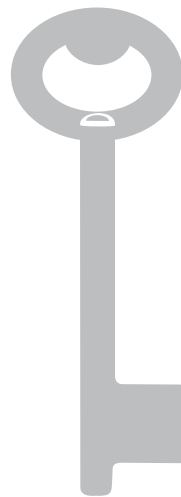

T9016
DOOR LOCK-R

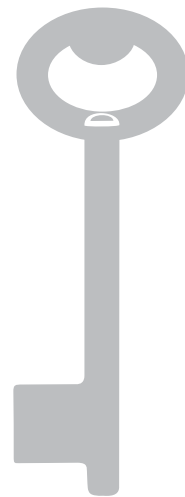

T9017
DOOR LOCK-L



GJ5
NIGHT LATCH



CGJ5R
NIGHT LATCH



T7266
6 LEVER



CGJ7R
6 LEVER

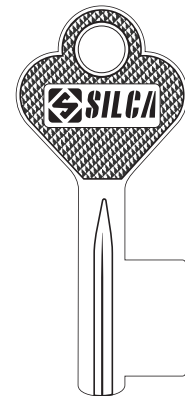

T8261
7 LEVER

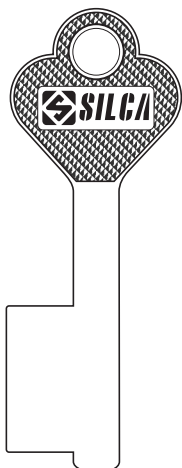

GJ6
8 LEVER

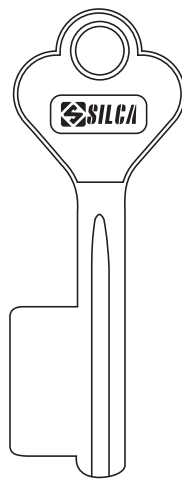

T7381
8 LEVER

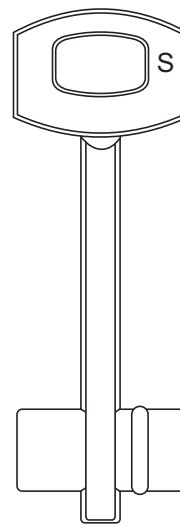

CS
SAFE KEY

FOR SCHLAGE

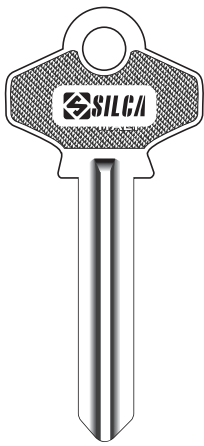

SH1
SCHLAGE



SH3
SCHLAGE

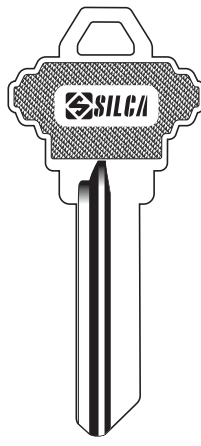

SH4
SCHLAGE

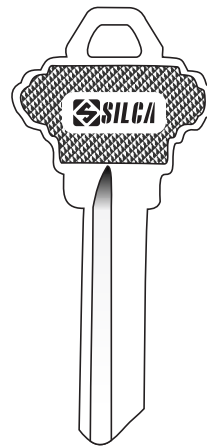

SH5
SCHLAGE



T3005
SCHLAGE

FOR TRICIRCLE / UNION



TL6R
TRICIRCLE

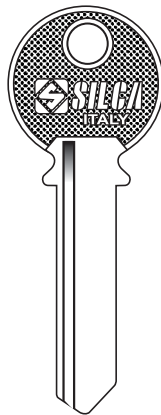

TL3
TRICIRCLE

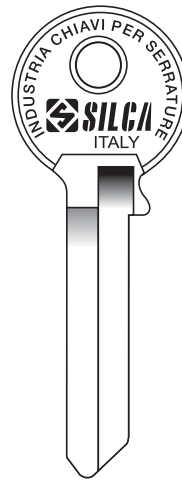

TL11R
TRICIRCLE



UNI3
UNION

FOR VIRO / EUROPA



VI080
VIRO / EUROPA



VI081
VIRO / EUROPA

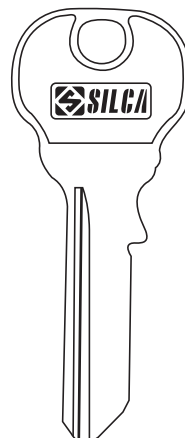

T7422
VI080-L

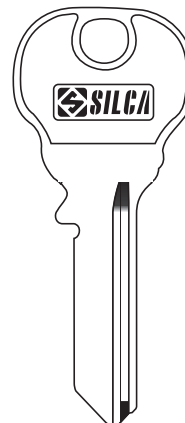

T7421
VI080-R



T7423
EUROPA
(STEEL)

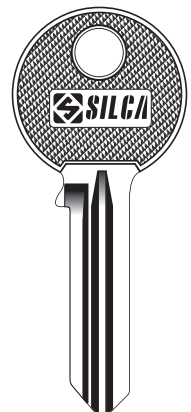

T8262
5-PIN



YA7
YALE



YA7A
YALE



YA226
YALE

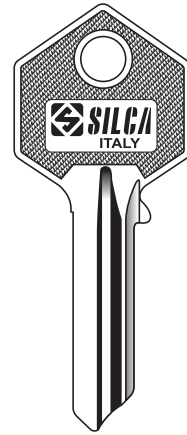

YA227
YALE



YA31
YALE

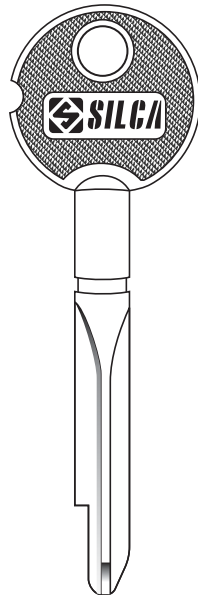

XY7
YALE



YA36
YALE

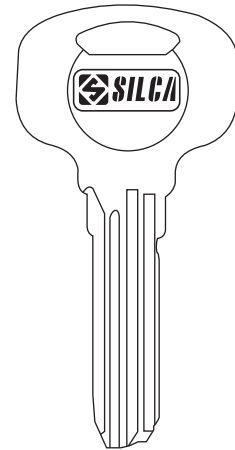

T7461
YALE



T7275
POLLAK

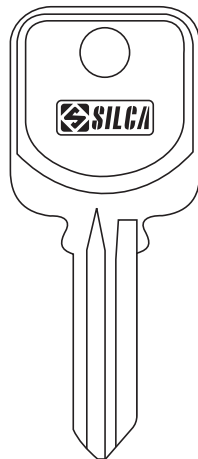

T7356
DEKSON

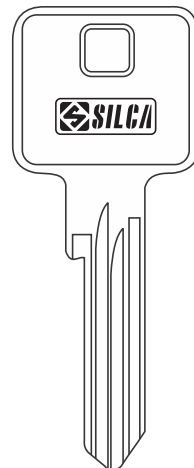

T7436
HAFELE (LONG)

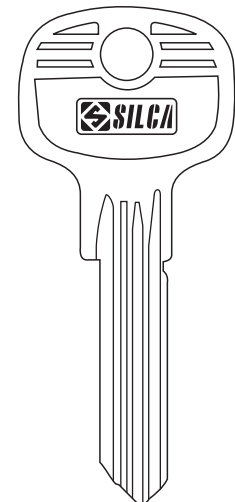

T7435
HAFELE (SHORT)

Domestic Keys



FOR SOLO / SOLEX

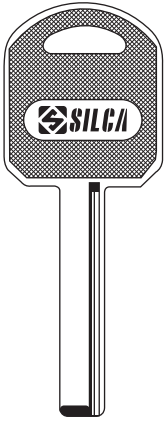

A1019Z
SOLO



A1022Z
SOLO

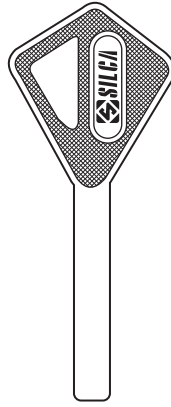

A1020Z
SOLO

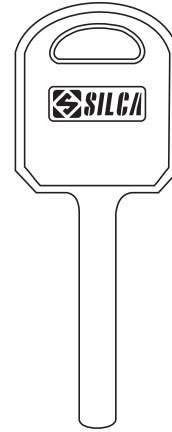

T7352
SOLO

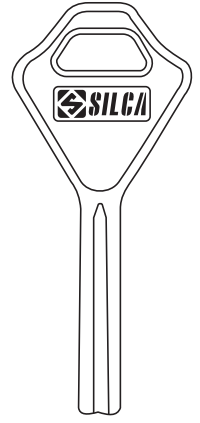

T7350
KRT

FOR LINK / SINCO / KALE

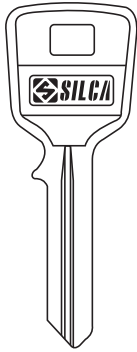

T7385
DRAWER
LOCK

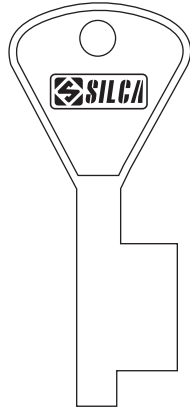

T7465
8 LEVER
(STEEL)

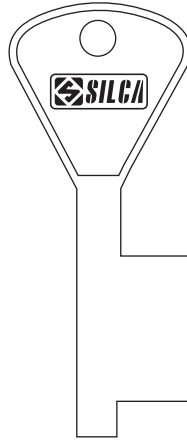

T7466
9 LEVER
(STEEL)

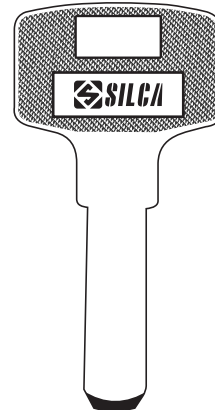

T7355
SINCO

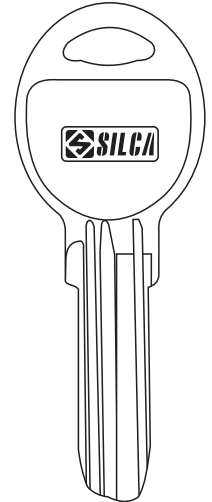

T7460
KALE

FOR GODREJ / DECO

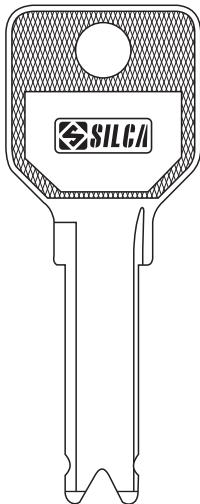

T7464
EVA LOCK



T7458
ULTRA XL PLUS

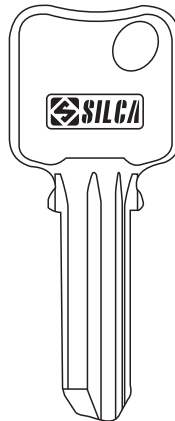

T7453
DECO-L

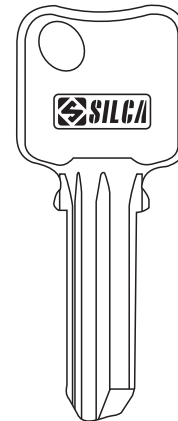

T7467
DECO-R



EXPAND BEYOND THE CORE

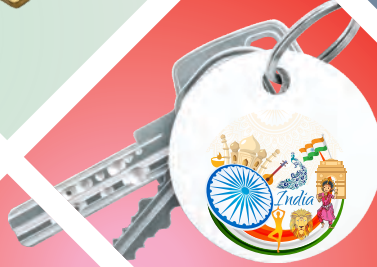
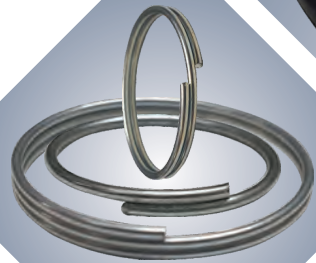

Our freestanding floor displays have been developed to present the , Silca accessories range in a professional way. Suitable as retail shop display or as compact key cutting work station where everything necessary to duplicate a key is close at hand.

This steel structure offers a compact key cutting work station where everything necessary to duplicate a key is close at hand.

- Dimensions: 62x180, 5x45cm.
- Takes weight up to 40 Kg and can be positioned at whatever height suits the user.
- Modular compartments for loose keys, consumables and accessories.
- Shelves and hooks can be placed as needed.
- Easy to transport and install.



CHIPOLO - Bluetooth Tracker

The smartest way to find your belongings. Chipolo is a small, colorful Bluetooth enabled device that easily attaches to your valuable items. With the free Chipolo app, locate any lost or misplaced item in seconds by ringing your it. Attach Chipolo to anything you don't want to lose. Connect it to the free Chipolo app. Ring Chipolo from the app or double press it to ring your phone. Even if it's on silent. Find your missing items. The app remembers when and where you last had them.



ATTACH

Chipolo to anything you don't want to lose Connect it to the free Chipolo app



FIND

Your missing items. The app remembers when and where you last had them.



RING

Chipolo from the app or double press it to ring your phone. Even if it's on silent.



Chipolo Bharat



Chipolo Confetti

Why the Chipolo ? Did you know that the average person spends 10 minutes a day looking for things they own but cannot find. We spent a great deal of effort, research and personal experience to design the Chipolo - a unique Bluetooth item finder that helps you locate your belongings.

For more info - <https://www.mindasilca.in/chipolo-bluetooth-key-finder.html>

SILICONE COVERS



Practical design created to protect your key from damages and scratches. Silca silicone cover are made of best quality silicon which are durable, flexible and odorless. Add colors to your key while making it easier for you to find the key in your bag, luggage & purse.

• **Available for** - Maruti Suzuki, Hyundai,

Toyota, Honda, Volkswagen, Ford, Renault, Skoda, Chevrolet, Mitsubishi, BMW, Mercedes, Audi, KD, Xhorse & Silca Universal Remotes.

- **Vehicle Segment** - 4 wheelers
- **Base Material** - Silicon
- **Standard Packaging** - 50 Units/Packaging.



KEY RING

Size - \varnothing 20 mm

Base Material - Spring Steel

Standard Packaging - 2000 Units/Packaging.

Size - \varnothing 20 mm

Base Material - Stainless Spring Steel

Standard Packaging - 2000 Units/Packaging

Size - \varnothing 28 mm

Base Material - Stainless Spring Steel

Standard Packaging - 2000 Units/Packaging.



LOCK PLATE LEVER

Available for : Minda lockset After Market Hero, Hero, Bajaj, Tata, Ashok Leyland, Force, Maruti, Mahindra, KTM, Kawasaki, ZLR, Honda Activa, Yamaha, Toyota, Daewoo.

Vehicle Segment - 2 wheelers / 4 wheelers

Base Material - Brass

Standard Packaging - 2000 Units/Packaging.



Silca Keys & Accessories StorZ (SKAZ)



Continuing with the effort of taking the locksmith business to more professional level, Minda Silca Engineering Pvt. Ltd. introduced the concept of Silca Keys & Accessories StorZ in India & South - East Asia. Minda Silca is not only providing them with the Basic & Advanced Machines / Automotive Devices / Keys / Brandings / Promotional Material & other infrastructure facilities, but also imparting the professionals with training on various aspects of locksmithing & making them aware on the legalized aspect of this locksmithing business.

PLATINUM CATEGORY

₹8.25 LAC+GST

DIAMOND CATEGORY

₹4.50 LAC+GST

GOLD CATEGORY

₹2.25 LAC+GST

SILVER PLUS CATEGORY

₹1.50 LAC+GST



AREA REQUIRED

9sq/m

DIVERSIFY YOUR EXISTING BUSINESS

EXISTING BUSINESS + SKAZ = EXTRA INCOME

CAN BE INCORPORATED IN ANY BUSINESS TO GET BETTER INCOME, DIVERSITY & GROWTH...!!!

FUTURA AUTO



FUTURA AUTO - Designed for key cutters who want to enter the automotive key business. Futura Auto is the easy-to-use electronic key cutting machine with integrated tablet, developed for duplicating all types of car keys. It can also cut Bike, Car, Van and Truck keys, and most complementary keys used for petrol cap locks, glove boxes and roof racks. Futura Auto features the same unique, compact and practical design as the best-selling Futura range.

RW5 / SMART AERIAL PLUS



Silca RW5 & Smart Aerial Plus is the fast, easy solution & reliable to duplicate transponders for around 99% of cloneable vehicle keys in circulation, including ID46 and ID48. Cloning calculations are made using Silca proprietary servers to guarantee reliability, ensuring that the latest routines are always available and time-consuming software updates are avoided.

TWISTER II



Twister II is an easy to use, reliable and convenient mechanical key cutting machine delivering accurate and consistent duplicates of dimple, laser and Fichet® type keys. The machine provides a range of optional accessories for expanding its capabilities to tubular keys and to a wide range of vehicle keys.

DUO

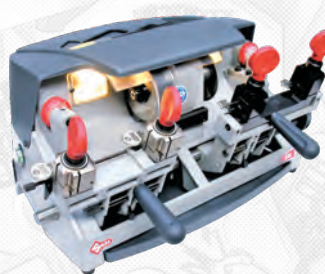

MKCM for making copies of flat cylinder, vehicle keys and cruciform keys (left-hand carriage); bit & double bit keys and mail box keys (right-hand carriage). Duo is solid, reliable, accurate & is made of long lasting components.

SWIFT PLUS



The mechanical key cutting machine for dimple, laser and tubular keys. Swift Plus is the mechanical key cutting machine for dimple, laser and tubular keys. Easy and comfortable to use and made with resistant and durable materials, Swift Plus is reliable over time ensuring quality cutting results.

FLASH 008



Flash 008 is the MKCM for flat cylinder and vehicle keys. It also cut cruciform keys, keys with long necks, tip stop and flip mechanisms. A fixing bracket allows the machine to be secured to the work-bench for better stability while cutting.

DUO LITE

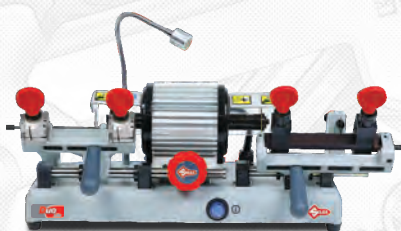

Mechanical key cutting machine for - flat cylinder and vehicles keys and cruciform keys (left side carriage) - bit and double bit, mail box and ® special keys such as Abus and ® Abloy keys (right side carriage).

FLASH MOBILE



FLASH MOBILE is a professional Battery-Operated Mechanical Key Cutting Machine for Flat Cylinder & Vehicle Keys. It also cuts Cruciform keys and keys with long necks, Tip stop & Flip mechanism. Flash Mobile is easy to use, Battery operated machine having superior quality PCB and other electronic components. Lightweight, Durable & Compact, it is perfect for small shops and mobile use.



MINDA SILCA ENGINEERING PVT. LTD.

Plot No. 37, Toy City, Greater Noida-201308, U.P.

Phone : +91 9871397630/31 • Whatsapp : +91 9311380181

• Customer care : +91 9560069957

E-mail : sales@mindsilca.in • Website : www.mindsilca.in

NETWORK WITH US



MINDA SILCA APP



Member **dormakaba** Group